

**OUR
CORE
CATALOGUE**

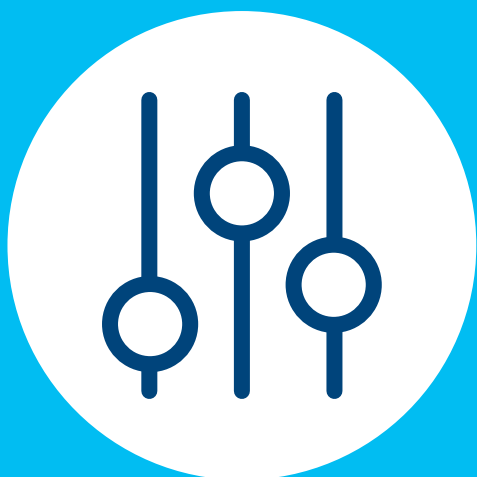

BETTER MOBILITY. BETTER LIFE.

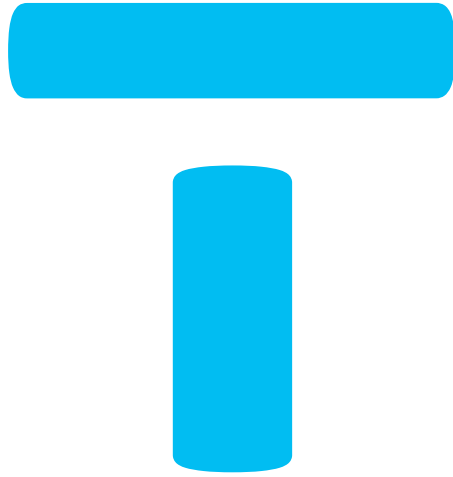



CONTENT

T	OUR BRAND PROMISE	2
T	CORE CATALOGUE	3
T	UNDERSTANDING & SELECTING YOUR PRODUCT	6
T	ONLINE WEB SHOP	12

Furniture

Blind Hole - Plastic Twin Wheeled Castors	14
Blind Hole - Nylon Twin Wheeled Castors (Low Height)	15
Blind Hole - Nylon Twin Wheeled Castors	16
Blind Hole - Polyurethane Twin Wheeled Castors	17
Blind Hole - Thermoplastic Wheeled Castors	18
Bolt Hole - Pressed Steel, Polyurethane Wheeled Castors	19
Bolt Hole - Pressed Steel, Plastic Wheeled Castors	20
Bolt Hole - Pressed Steel, Thermoplastic Wheeled Castors	21
Bolt Hole - Pressed Steel, Thermoplastic Twin Wheeled Castor	23
Bolt Hole - Synthetic, Thermoplastic Wheeled Castors	24
Plate - Pressed Steel, Nylon Wheeled Castors	25
Plate - Pressed Steel, Polyurethane Wheeled Castors	26
Plate - Pressed Steel, Plastic Wheeled Castors	27
Plate - Pressed Steel, Thermoplastic Wheeled Castors	28
Plate - Pressed Steel, Thermoplastic Twin Wheeled Castors	29

Point of Sale

Blind Hole - Plastic Twin Wheeled Castors	30
Blind Hole - Nylon Twin Wheeled Castors (Low Height)	31
Blind Hole - Nylon Twin Wheeled Castors	32
Blind Hole - Polyurethane Twin Wheeled Castors	33
Blind Hole - Thermoplastic Wheeled Castors	34
Bolt Hole - Pressed Steel, Polyurethane Wheeled Castors	35
Bolt Hole - Pressed Steel, Plastic Wheeled Castors	36
Bolt Hole - Pressed Steel, Thermoplastic Wheeled Castors	37
Bolt Hole - Pressed Steel, Thermoplastic Twin Wheeled Castor	39
Bolt Hole - Pressed Steel, Nylon Wheeled Castors	40
Bolt Hole - Synthetic, Thermoplastic Wheeled Castors	41
Plate - Pressed Steel, Nylon Wheeled Castors	42
Plate - Pressed Steel, Polyurethane Wheeled Castors	43
Plate - Pressed Steel, Plastic Wheeled Castors	44
Plate - Pressed Steel, Thermoplastic Wheeled Castors	45
Plate - Pressed Steel, Thermoplastic Twin Wheeled Castors	46
Plate - Pressed Steel, Solid Rubber Wheeled Castors	47
Plate - Pressed Steel, Nylon Wheeled Castors	49

Medical

Blind Hole - Polyurethane Twin Wheeled Castors	50
Blind Hole - Synthetic, Thermoplastic Wheeled Castors	51
Bolt Hole - Stainless Steel, Thermoplastic Wheeled Castors	52
Bolt Hole - Pressed Steel, Thermoplastic Wheeled Castors	53
Bolt Hole - Pressed Steel, Thermoplastic Twin Wheeled Castors	54
Bolt Hole - Synthetic, Thermoplastic Wheeled Castors	55
Plate - Pressed Steel, Thermoplastic Wheeled Castors	56
Plate - Pressed Steel, Thermoplastic Twin Wheeled Castors	57

Hardware

Bolt Hole - Pressed Steel, Polyurethane Wheeled Castors	58
Bolt Hole - Pressed Steel, Plastic Wheeled Castors	59
Bolt Hole - Pressed Steel, Rubber Wheeled Castors	60
Bolt Hole - Pressed Steel, Polyurethane Wheeled Castors	61
Bolt Hole - Pressed Steel, Elastic Rubber Wheeled Castors	62
Plate - Pressed Steel, Nylon Wheeled Castors	63
Plate - Pressed Steel, Polyurethane Wheeled Castors	64
Plate - Pressed Steel, Plastic Wheeled Castors	65
Plate - Pressed Steel, Thermoplastic Wheeled Castors	66
Plate - Pressed Steel, Solid Rubber Wheeled Castors	67
Plate - Pressed Steel, Elastic Rubber Wheeled Castors	69
Plate - Pressed Steel, Polyurethane Wheeled Castors	71

Distribution

Bolt Hole - Pressed Steel, Elastic Rubber Wheeled Castors	73
Bolt Hole - Pressed Steel, Nylon Wheeled Castors	74
Plate - Pressed Steel, Solid Rubber Wheeled Castors	75
Plate - Pressed Steel, Elastic Rubber Wheeled Castors	77
Plate - Pressed Steel, Nylon Wheeled Castors	79
Plate - Pressed Steel, Polyurethane Wheeled Castors	80
Plate - Pressed Steel, Vulcanized Elastic Wheeled Castors	82
Plate - Reinforced Pressed Steel, Polyurethane Casted	83

Food & Catering

Bolt Hole - Stainless Steel, Thermoplastic Wheeled Castors	84
Bolt Hole - Pressed Steel, Thermoplastic Wheeled Castors	85
Bolt Hole - Pressed Steel, Nylon Wheeled Castors	86
Bolt Hole - Pressed Steel, Elastic Rubber Wheeled Castors	87
Bolt Hole - Synthetic, Thermoplastic Wheeled Castors	88
Plate - Stainless Steel, Nylon Wheeled Castors	89
Plate - Pressed Steel, Nylon Wheeled Castors	90
Plate - Pressed Steel, Thermoplastic Wheeled Castors	91
Plate - Pressed Steel, Heat Resistant Synthetic Wheeled Castors	92
Plate - Stainless Steel, Heat Resistant Synthetic Wheeled Castors	93
Plate - Pressed Steel, Elastic Rubber Wheeled Castors	94
Plate - Pressed Steel, Polyurethane Wheeled Castors	96

CONTENT

Cleaning and Maintenance

Bolt Hole - Stainless Steel, Thermoplastic Wheeled Castors.....	98
Bolt Hole - Pressed Steel, Nylon Wheeled Castors	99
Bolt Hole - Pressed Steel, Elastic Rubber Wheeled Castors.....	100
Plate - Stainless Steel, Nylon Wheeled Castors	101
Plate - Pressed Steel, Nylon Wheeled Castors	102
Plate - Pressed Steel, Heat Resistant Synthetic Wheeled Castors ..	103
Plate - Stainless Steel, Heat Resistant Synthetic Wheeled Castors ..	104
Plate - Pressed Steel, Elastic Rubber Wheeled Castors	105
Plate - Pressed Steel, Polyurethane Wheeled Castors.....	107

Intralogistics

Bolt Hole - Pressed Steel, Polyurethane Wheeled Castors	109
Bolt Hole - Pressed Steel, Elastic Rubber Wheeled Castors	110
Bolt Hole - Pressed Steel, Nylon Wheeled Castors	111
Plate - Pressed Steel, Solid Rubber Wheeled Castors.....	112
Plate - Pressed Steel, Elastic Rubber Wheeled Castors	114
Plate - Pressed Steel, Nylon Wheeled Castors	116
Plate - Pressed Steel, Polyurethane Wheeled Castors.....	117
Plate - Pressed Steel, Vulcanized Elastic Wheeled Castors	118
Plate - Steel Welded, Polyurethane Casted Castors	119
Plate - Reinforced Pressed Steel, Polyurethane Casted Castors.....	120

Machinery & Workshops

Bolt Hole - Pressed Steel, Polyurethane Wheeled Castors	121
Plate - Pressed Steel, Nylon Wheeled Castors	122
Plate - Pressed Steel, Polyurethane Wheeled Castors.....	123
Plate - Steel Welded, Polyurethane Casted Castors	124
Plate - Reinforced Pressed Steel, Polyurethane Casted Castors.....	125

Wheels

Wheel - Foam Filled Wheel (Ø260)	126
Wheel - Elastic Tyre Wheels (Ø100 - Ø200).....	127
Wheel - Heat Resistant Elastic Tyre Wheels (Ø100)	129
Wheel - Nylon Wheels (Ø80 - Ø200)	130
Wheel - Heat Resistant Synthetic Wheels (Ø80 & Ø100)	132
Wheel - Polyurethane Wheels (Ø80 - Ø200)	133
Wheel - Heavy Duty Polyurethane Wheels (Ø100 - Ø200).....	134
Wheel - Rubber Wheels (Ø100 - Ø200)	136
Wheel - Thermoplastic Rubber Wheels (Ø50 - Ø125)	138

Fittings

Stems - Threaded, Circlip Stem, Round & Square Expanders.....	139
Plate - Push-in Plate Fittings	140

APPLICATION INDEX

141

TENTE SERVICES

142

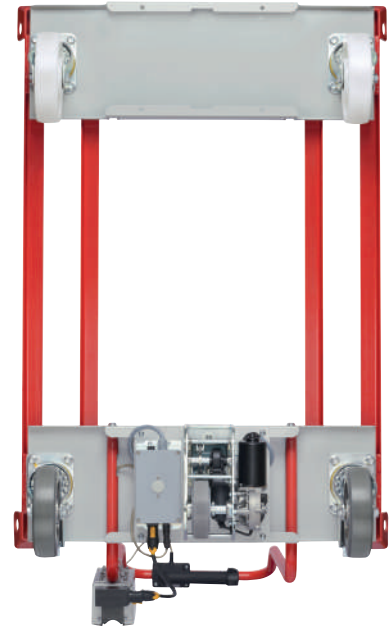

Better Mobility. Better Life.

There are some significant terms which are closely associated with the word 'mobility': progress, movement, flexibility and drive. They all shape our modern lives and are essential for success and development. It is for exactly this reason that at TENTE we work on driving mobility forward every day – with our trailblazing castors and wheels – with uncompromising standards of quality – and above all, with a clear brand promise: Better Mobility. Better Life.

TENTE has been developing smart mobility solutions since 1923. Solutions which noticeably improve people's lives and their working environment. Solutions which increase productivity, ensure more safety and open up new horizons in matters of design, durability as well as environmental friendliness – and that means in all aspects of life. No matter whether it's for industry, commerce, medical technology, heavy goods transport, mechanical engineering, intralogistics, factory equipment or the furniture sector: TENTE's castors and wheels set new standards and put influential changes in motion. By doing this, we enjoy our customers' confidence not only because of the high quality of our products and our innovative spirit, but especially due to the close customer support which we provide on five continents.

On the following pages we would like to explain in detail which values form the basis of our multiple strengths, in which outstanding mobility solutions manifest themselves and which far-reaching improvements can be brought about – for mobility – for all sectors of life – and of course for our customers.

OUR CORE CATALOGUE

WHAT DOES IT CONTAIN?



Quick and easy to find the right product.

With our core catalogue, it is easier to find the right product for the right application due to our division of industries and applications.



Discover the features of our wheels and castors.

Our core catalogue allows you to quickly identify the technical characteristics of the wheel and/or castor you have chosen.



If you order from the assortment in our core catalogue, you can count on the fastest delivery times:

- The assortment is stocked.
- Your order will be sent no later than the following day.



Your order is shipped to you!

After placing your order, you will receive it in 24-48 hours!

OUR CORE CATALOGUE

WHAT DOES IT CONTAIN?

Each of our product families are defined by specific criteria. The focus can lie on a high design standard, a special feature, an additional benefit for an application or an exceptional load capacity. From the correct dimensions and technical specifications to the required configuration, whatever you need, our product families can offer you the ideal solution.

Contact us for more information or visit our website:

www.tente.co.uk

www.tente.co.uk

E-Drive



⌀ 125 mm

Alpha



⌘ 70 - 500 kg
⌀ 58 - 250 mm

Delta



⌘ 300 - 600 kg
⌀ 125 - 200 mm

Delta twin



⌘ 600 - 750 kg
⌀ 125 - 200 mm

Zeta



⌘ 300 - 800 kg
⌀ 125 - 250 mm

Kappa



⌘ 300 - 2000 kg
⌀ 80 - 300 mm

Kappa flex



⌘ 360 - 750 kg
⌀ 160 - 200 mm

Omikron



⌘ 900 - 6000 kg
⌀ 100 - 500 mm

Radiata

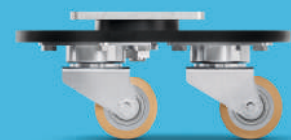

⌘ 1200 - 1500 kg
⌀ 80 mm

Scout



150 - 250 kg
160 - 200 mm

Integral



80 - 150 kg
100 - 200 mm

Integral twin



125 - 250 kg
100 - 150 mm

Linea



40 - 150 kg
50 - 150 mm

Aviana



100 kg
75 mm

Agila



40 - 100 kg
50 - 150 mm

Stora



55 - 160 kg
75 - 160 mm

Mono



30 - 70 kg
50 - 100 mm

Galea



60 - 100 kg
100 - 125 mm

Levina



60 - 100 kg
75 - 150 mm

Anika



40 - 50 kg
55 - 75 mm

Lumina



20 - 100 kg
35 - 100 mm

Stylea



40 - 100 kg
35 - 100 mm

Smiles



40 kg
50 mm

Compacta



10 - 40 kg
14 - 50 mm

FUNDAMENTAL REQUIREMENTS

What requirements do you have for your application? It is important aspect to know what you require from your castors and wheels. Get to know the most important characteristics, define your requirements and find the right product for your needs.



LOAD CAPACITY

The load capacity per roller is determined by the sum of the weight of the transport device and the maximum payload divided by 3:

$$\frac{\text{Total Weight}}{3}$$



HEIGHT

The height of a castor is described as the total height when installed.



WHEEL DIAMETER

The larger the diameter, the easier obstacles are overcome.



TEMPERATURE RESISTANT

Castors and wheels for applications from - 40 ° C to + 280 ° C are available.

ELECTRICALLY CONDUCTIVE

To avoid electrostatic discharge, we offer castors and wheels in electrically conductive design.

CORROSION RESISTANCE

For castors and wheels used in humid environments or in contact with aggressive substances, TENTE offers versions with durable materials and surfaces.



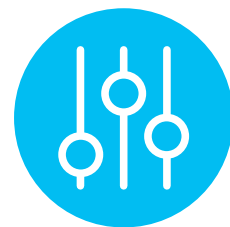

MOUNTING

Blind Hole
Bolt Hole
Plate

Quick installation with plug-in fitting for push-in, plate or round and square tubes.
Simple central screw connection.
Plate with multiple screw connection.

BRAKE

Wheel Lock
Directional Lock
Total Lock
Central Braking

Prevents the rotation of the wheel.
Fixes the running direction of the movement.
Fixes the rotation and pivotal movement of the wheel.
Simultaneously fixes multiple castors.

BEARING

Bearings
Roller Bearing
Precision Ball Bearing

Standard bearings, robust, moisture-resistant.
Standard bearings, robust, smooth running.
High performance bearings, for all areas.

FLOOR CONTACT

Soft Floors
Hard Floors

Harder wheels recommended
Softer wheels recommended

TREAD

Soft Materials
Hard Materials

Lower driving noise, stronger damping, higher protection of the cargo
Increased driving noise, lower damping, less protection of the cargo

WEAR RESISTANCE

Flat Ground
uneven Ground

Lower rolling resistance, abrasion and wear
Higher rolling resistance, abrasion and wear

OUR CORE CATALOGUE

THE NAMING PROCESS

Effective naming:

To simplify the selection process, we have developed an order number system that identifies all product characteristics.

Explanation of the TENTE order number system:

The simple and logically organized structure of the TENTE order number system enables you to quickly identify each wheel.

Bracket				Wheel				Attachment	
3	4	7	0	I	T	P	100	P62	105X85
Material	Shape of Fork	Swivel Bearings	Castor Type	Wheel Body	Tread	Bearing	Wheel Diameter (mm)	Fitting Type	Dimensions of Fitting (mm)



Example:

3470 ITP 100 P62 - 105x85

- 3** Material:
Pressed Steel Sheet
- 4** Shape of Fork:
Wide
- 7** Swivel Bearings:
Double Ball Bearings
- 0** Castor Type
Swivel Castor
- I** Wheel Body
Aluminium
- T** Tread:
Polyurethane
- P** Bearing:
Precision Ball Bearing

1 0 0 Wheel Dimensions (mm)

P62 Fitting Type:
Rectangular Plate Fitting

105x85 Dimensions of Fitting (mm):
105 x 85 mm

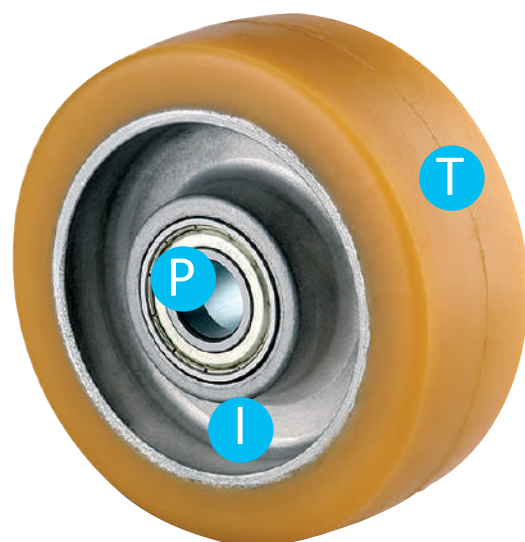
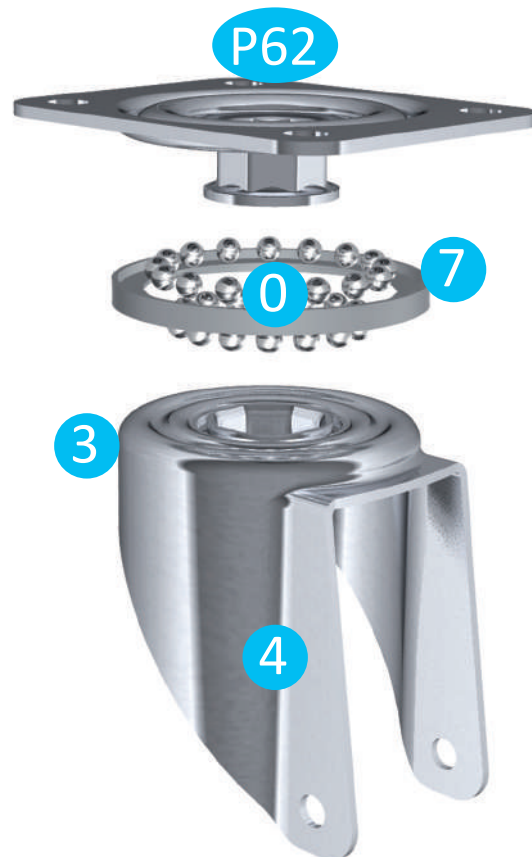

OUR CORE CATALOGUE

THE NAMING PROCESS

Bracket			Wheel	
Material	Shape of Fork	Swivel Bearing	Castor Type	Wheel Body
0 Wire and other profiles made of metal	0 Closed	0 Fixed stem	0 Swivel castor	A
1 Steel sheet, light	1 Angular	1 One ball raced, edged	1 Directional lock	B heat-resistant, duroplastic one ball C Polyurethane, casted
2 Steel sheet, medium	2 Straight	2 Stem, swivelling	2 Total lock, head end of castor	D Pressed steel E Steel, iron F Cast iron
3 Steel sheet, heavy	3 Slim	3 One ball race	3 Intermittend (LA) brake	G Asymmetrical wheel H Shock absorbing wheel body (hybrid)
4 Steel sheet, very heavy	4 Broad	4 Precision ball bearing	4 Central, total or directional lock	I Aluminium J Zinc-die-casted
5 Polyamide	5 Double wheel closed with dome	5 Deep-groove ball thrust and tapered	5 Wheel brake	K L Wood
6 Zinc-due-casting / Alu	6 Broad, reinforced	6 Double ball bearing, wivel head, welded	6 Central, total lock	M Polyamide PA, extra heavy duty N Stainless steel / Nirosta
7 Stainless steel for institutional wheels	7 With Spring	7 Two ball race	7 Total lock, tail end of castors	O P Polypropylene PP
8 Stainless steel for industrial wheels	8 Special features	8 Two ball race, reinforced	8 Fixed castor	Q Polyurethane, injected R
9 Cast iron, or iron forged, heavy	9 Twin wheel castor	9 Free for fixed castors	9 Special feature	S Steel sheet, heavy T Polyamide PA, heavy duty
A Polypropylene	A Twin wheel castor, closed		A	U Polyamide PA V Solid rubber W Heat-resistant, thermoplastic synthetic X Polyamide PA, electric conductive Y Polypropylene PP, electric conductive Z Flanged wheel

Attachment

Tread	Bearing	Fitting Type
A PUR Polyurethane, injected	A Plain hub	P P 30 Center bolt bracket
B PVC casted	B Bore hole with keyway	P 40 Fixing plate 60 x 60 mm
C PUR poured HITEC	C Precision bearings stainless	P 41 Fixing plate 55 x 55 mm
D Shock absorbing, heat-resistant	D Roller bearing, stainless	P 50 Fixing plate 77 x 67 mm
E Elastic tyre, black, vulcanized	E Cone ball bearing, stainless	P 62 Fixing plate 105 x 85 mm
F Elastic tyre, non-marking, vulcanized	F Flange wheel	P 63 Fixing plate 137 x 105 mm
G Electric conductive injected rubber	G Self-lubricating bushing	P 64 Fixing plate 175 x 140 mm
H Antistatic	H Plain bearing with threadguards	P 65 Fixing plate 200 x 160 mm
I Solid rubber, non-marking	I Plain bearing without threadguard or spacer	P 66 Fixing plate 250 x 200 mm
J Injected rubber PP soft	J Roller bearings with threadguards	P 67 Fixing plate with central locking
K PP - soft	K Cone ball bearing	
L Solid rubber tyre, yellowline	L Roller bearings with metal bushes	S S 70 Threaded Stem with heaxagon neck
M Double flanged with tracks	M Plain bearing, stainless	
N PU, foam	N End Wheel	B B 10 Push-In Stem with Circlip
O Same material as wheel body	O Plain bearing without threadguard	
P Pneumatic, line profile	P Precision ball bearings	L L 51 Holes for fixing pins
Q Pneumatic, patterned profile	Q Taper bearing	
R Recycled solid rubber	R Roller bearing without threadguard	R R 07 Plastic expander (round)
S PUR injected, electric conductive	S Roller bearing, noise reduction	R 47 Plastic expander (square)
T PUR casted	T Precision ball bearing, noise reduction	
U Polyamide	U Plain bearing, synthetic spacer	
V Solid rubber, black	V	
W Hard-soft rubber	W	
X Tires for waste disposal systems	X Precision ball bearing, sealed	
Y Solid rubber, black, electric conductive	Y Precision ball bearing, RS or 2 RS	
Z	Z Bore, blank	

ORDER CASTORS & WHEELS ONLINE - TENTE.CO.UK



Order quickly and efficiently with TENTE UK's new online web shop! With our exclusive range we can get products shipped to you in 24-48 hours.

MAKE USE OF OUR EASY TO USE NAVIGATION AND PRODUCT FILTER SYSTEM!

Visit our website to easily find your desired product(s) via your industry, application, or product specifications. In addition, benefit from our speedy delivery system!

Request our Core Catalogue or view it online!

www.tente.co.uk

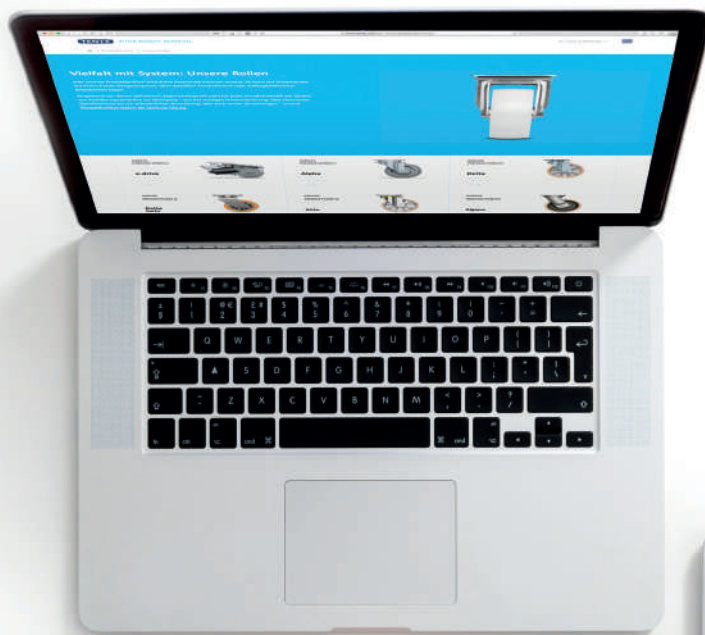

Enjoy a quick and easy way
to find your product(s)!



Notes





A series of horizontal dotted lines for writing notes.

FURNITURE

Blind Hole - Plastic Twin Wheeled Castors

Flexible Design

The Lumina with Basetech has the ability to have flexible fitting options and different dome sizes. In return, these castors allow for a perfect transition from castor to application.

-  **Load capacity:** 40 kg
-  **Temperature:** - 10 / + 40 °C
-  **Overall height:** 56 mm
-  **Wheel diameter:** 50 mm

	Wheel diameter [mm]	Width of Tread [mm]	Castor width [mm]	Centre hole [mm]	Swivel Radius [mm]	Overall height [mm]	Load capacity [kg]	Serial number	Order number
Swivel Castors	50	7	54	8	48	56	40	A520POI050L51-8	00072993
Swivel Castors with wheel brake	50	7	54	8	62	56	40	A525POI050L51-8	00072994



See Page 139-140 for more information and sizes

Technical Information

Housing made of Polypropylene with blind hole for furniture fittings. Wheel centre is made up of Polypropylene with plain bearing.

Advantages at a glance





Roll performance	● ● ● ○ ○
Movement noise	● ● ● ○ ○
Attrition	● ● ● ○ ○
Corrosion resistance	● ● ● ○ ○

















FURNITURE

Blind Hole - Nylon Twin Wheeled Castors (Low Height)

Low Height & Maximum Manoeuvrability

The Stylea with Duratech has a variety of fitting options and dome sizes, as well as lengths. It also has high manoeuvrability due to its twin wheels, which allow less friction when moving or adjusting direction.

-  **Load capacity:** 50 kg
-  **Temperature:** - 20 / + 60 °C
-  **Overall height:** 31 mm
-  **Wheel diameter:** 35 mm

	Wheel diameter [mm]	Width of Tread [mm]	Castor width [mm]	Centre hole [mm]		Swivel Radius [mm]	Overall height [mm]	Load capacity [kg]		Serial number	Order number
Swivel Castors	 35	 11	 52	 10		 37	 31	 50		5920UOI035L51-10 LOW	00078712
											
Swivel Castors with wheel brake	 35	 11	 52	 10		 45	 31	 50		5925UOI035L51-10 LOW	00770069
											



See Page 139-140 for more information and sizes

Technical Information

Housing is made of Polyamide with blind hole for furniture fittings, while the wheel centre consists of Polyamide with plain bearing. Other tread options available!

Advantages at a glance





Roll performance	● ● ● ○ ○
Movement noise	● ● ● ○ ○
Attrition	● ● ● ● ●
Corrosion resistance	● ● ● ● ○

FURNITURE

Blind Hole - Nylon Twin Wheeled Castors

Visual Integration

The Stylea with Supratech is a twin wheel castor with high manoeuvrability and load capacity. It has the ability to come in a variety of fitting, dome sizes and lengths in order to provide you with a solution that integrates perfectly into your application.

-  **Load capacity:** 50 kg
-  **Temperature:** - 10 / + 40 °C
-  **Overall height:** 68 - 77 mm
-  **Wheel diameter:** 65 - 75 mm

	Wheel diameter [mm]	Width of Tread [mm]	Castor width [mm]	Centre hole [mm]	Dome-Ø [mm]	Swivel Radius [mm]	Overall height [mm]	Load capacity [kg]	Serial number	Order number
Swivel Castors	65	7	42	10	23	53	68	50	5920UJI065L51-10 DOM23 ALU	00601715
	75	8	53	10	20	62	77	50	5920UJI075L51-10 DOM20 ALU	00071016
Swivel Castors with wheel brake	65	7	42	10	23	77	68	50	5925UJI065L51-10 DOM23 ALU	00074624
	75	8	53	10	20	87	77	50	5925UJI075L51-10 DOM20 ALU	00074645



See Page 139-140 for more information and sizes

Technical Information

Housing made of Polyamide with blind hole for furniture fittings. Wheel centre made of Polyamide, while the tread consist of TENTEprene (thermoplastic rubber) with plain bearing. Other tread options available!

Advantages at a glance

Roll performance	● ● ● ○ ○
Movement noise	● ● ● ○ ○
Attrition	● ● ● ○ ○
Corrosion resistance	● ● ● ● ○

FURNITURE

Blind Hole - Polyurethane Twin Wheeled Castors

Complete Customisation





The Linea with Maxtech is a twin wheel castor that has a wide range of flexible fittings in various sizes, as well as different dome diameters and lengths for a perfect transition from castor to application. Additionally, you can customise the colour and even add your logo.

Load capacity: 90 - 100 kg

Temperature: - 10 / + 40 °C

Overall height: 50 - 100 mm

Wheel diameter: 50 - 100 mm

	Wheel diameter [mm]	Width of Tread [mm]	Castor width [mm]	Centre hole [mm]	Dome-Ø [mm]	Swivel Radius [mm]	Overall height [mm]	Load capacity [kg]	Serial number	Order number
Swivel Castors	50	13	47,5	10	23	40,5	50	100	5920UAP050L51-10 LOAD 9002	00603618
										
Swivel Castors	65	13.9	46	10	23	56	68	90	5920UAP065L51-10 Ral 9002	00603453
	75	15	55	10	30	65	75,5	100	5920UAP075L51-10 RAL9002	00770568
	100	20	73	11	40	88	100	100	5920UAP100L51-11 RAL9002	00079772
										
Swivel Castors with wheel brake	50	13	47,5	10	23	51	50	100	5925UAP050L51-10 LOAD 9002/7015	00603620
										
Swivel Castors with intermittend brake	65	13.9	46	10	23	67	68	90	5925UAP065L51-10 Ral 9002 BWR 7015	00603454
	75	15	55	10	30	81	75,5	100	5925UAP075L51-10 RAL9002 BWR 7015	00771092
	100	20	73	11	40	102	100	100	5925UAP100L51-11 Ral 9002	00079773
										

Other Colour Options:



Fitting Options:



See Page 139-140 for more information and sizes [Advantages at a glance](#)

Technical Information

Wheel centre is made up of Polyamide with blind hole for furniture fittings. Tread consisting of Polyurethane with a precision ball bearing. Other tread options available!

Roll performance	● ● ● ● ●
Movement noise	● ● ● ● ○
Attrition	● ● ● ● ●
Corrosion resistance	● ● ● ● ○

FURNITURE

Blind Hole - Thermoplastic Wheeled Castors



Durability Meets Design

The Levina with Supratech is the ideal castor for durability and design. It has extremely high shock absorbance and its soft wheel version allows for the reduction of noise. Additionally, it has been awarded an award-winning design for its distinguished appearance.

- Load capacity:** 75 kg
- Temperature:** - 10 / + 40 °C
- Overall height:** 103 mm
- Wheel diameter:** 75 mm

	Wheel diameter [mm]	Width of Tread [mm]	Centre hole [mm]	Swivel Radius [mm]	Overall height [mm]	Load capacity [kg]	Serial number	Order number
Swivel Castors	75	25	10	64,5	103	75	5320PJP075L51-10	00602801
Swivel Castors with wheel brake	75	25	10	73	103	75	5325PJP075L51-10	00037167



Fitting Options:

P41

B10

S70

See Page 139-140 for more information and sizes

Technical Information

Housing and wheels made from high grade synthetic materials, with integrated thread guards with blind hole for furniture fittings. The wheel centre is made of Polypropylene, while the tread consists of TENTEprene (thermoplastic rubber), grey non-marking, precision ball bearing, with thread guards. Other tread options available!

Advantages at a glance





Roll performance	● ● ● ○ ○
Movement noise	● ● ● ● ○
Attrition	● ● ● ○ ○
Corrosion resistance	● ● ● ● ○

FURNITURE

Bolt Hole - Pressed Steel, Polyurethane Wheeled Castors

Environmentally Practical & User Friendly

The Aglia with Maxtech is a practical system solution with an ideal wheel material for every purpose. They are low-maintenance castors that are perfect for those that want to avoid markings on their floors.

-  **Load capacity:** 40 - 60 kg
-  **Temperature:** - 20 / + 60 °C
-  **Overall height:** 70 - 100 mm
-  **Wheel diameter:** 50 - 75 mm

	Wheel diameter [mm]	Width of Tread [mm]	Centre hole [mm]		Offset [mm]	Overall height [mm]	Load capacity [kg]		Serial number	Order number
Swivel Castors	50	19	11		25	70	40		1470PAO050P30-11	00031098
	75	25	11		25	100	60		1470PAO075P30-11	00031102
Swivel Castors with wheel brake	50	19	11		25	70	40		1475PAO050P30-11	00031099
Swivel Castors with total lock	75	25	11		25	100	60		1477PAO075P30-11	00031104

Technical Information

Housing made of pressed steel, bright zinc plated, blue passivated with double ball bearing swivel head and bolt hole. Wheel centre is made of Polypropylene and the tread consists of Polyurethane with plain bearing. Other tread options available!

Advantages at a glance





Roll performance	● ● ● ○ ○
Movement noise	● ● ● ○ ○
Attrition	● ● ● ● ○
Corrosion resistance	● ● ● ○ ○

FURNITURE

Bolt Hole - Pressed Steel, Plastic Wheeled Castors

Durable & Hygienic

The Aglia with Maxtech is a practical system solution with an ideal wheel material for every purpose. They are low-maintenance castors that are perfect for those that want to avoid markings on their floors.

-  **Load capacity:** 40 kg
-  **Temperature:** - 20 / + 60 °C
-  **Overall height:** 70 mm
-  **Wheel diameter:** 50 mm

	Wheel diameter [mm]	Width of Tread [mm]	Centre hole [mm]		Offset [mm]	Overall height [mm]	Load capacity [kg]		Serial number	Order number
Swivel Castors	50	18	11		25	70	40		1470POO050P30-11	00031100
Swivel Castors with wheel brake	50	18			25	70	40		1475POO050P30-11	00031101



Technical Information

Housing made of pressed steel, bright zinc plated, blue passivated with double ball bearing swivel head and bolt hole. Wheel centre is made of Polypropylene and the tread consists of Polyurethane with plain bearing. Other tread options available!

Advantages at a glance

Roll performance	● ● ● ○ ○
Movement noise	● ● ● ○ ○
Attrition	● ● ● ● ●
Corrosion resistance	● ● ● ○ ○

FURNITURE

Bolt Hole - Pressed Steel, Thermoplastic Wheeled Castors

Low Maintenance Mobility



This Agila with Supratech is a single wheel castor that has the option to have a thread guard or not depending on your needs. The thread guard version allows for low maintenance due to less obstructions and minimal cleaning is needed.

 **Load capacity:** 40 - 100 kg

 **Temperature:** - 20 / + 60 °C

 **Overall height:** 69 - 160 mm

 **Wheel diameter:** 50 - 125 mm

	Wheel diameter [mm]	Width of Tread [mm]	Centre hole [mm]	Offset [mm]	Overall height [mm]	Load capacity [kg]	Serial number	Order number
Swivel Castors	50	19	11	24	69	40	2470PJI050P30-11	00004530
	75	25	11	24	100	75	2470PJO075P30-11	00003349
	100	32	13	38	135	80	2470PJO100P30-13	00005162
	125	32	13	41	160	100	2470PJP125P30-13	00027435
Swivel Castors with wheel brake	50	19	11	24	69	40	2475PJO050P30-11	00003896
								

Technical Information

Housing made of pressed steel, bright zinc plated, blue passivated, double ball bearing swivel head, wheel axle with nut and bolt hole. Wheel centre is made of Polypropylene and the tread consists of TENTEprene (thermoplastic rubber), grey non-marking, precision ball bearing, with or without thread guards. Other tread options available!

Advantages at a glance

Roll performance	● ● ● ○ ○
Movement noise	● ● ● ○ ○
Attrition	● ● ● ○ ○
Corrosion resistance	● ● ● ○ ○

FURNITURE

Bolt Hole - Pressed Steel, Thermoplastic Wheeled Castors

Low Maintenance Mobility



This Agila with Supratech is a single wheel castor that has the option to have a thread guard or not depending on your needs. The thread guard version allows for low maintenance due to less obstructions and minimal cleaning is needed.

 **Load capacity:** 75 - 100 kg

 **Temperature:** - 20 / + 60 °C

 **Overall height:** 100 - 160 mm

 **Wheel diameter:** 75 - 125 mm

	Wheel diameter [mm]	Width of Tread [mm]	Centre hole [mm]		Offset [mm]	Overall height [mm]	Load capacity [kg]		Serial number	Order number
Swivel Castors with total lock 	75	25	11		24	100	75		2477PJO075P30-11	00003358
	100	32	13		43,5	135	80		2477PJO100P30-13	00005170
Swivel Castors with total lock 	125	32	13		41	160	100		2477PJP125P30-13	00603359

Technical Information

Housing made of pressed steel, bright zinc plated, blue passivated, double ball bearing swivel head, wheel axle with nut and bolt hole. Wheel centre is made of Polypropylene and the tread consists of TENTEprene (thermoplastic rubber), grey non-marking, precision ball bearing, with or without thread guards. Other tread options available!

Advantages at a glance





Roll performance	● ● ● ○ ○
Movement noise	● ● ● ○ ○
Attrition	● ● ● ○ ○
Corrosion resistance	● ● ● ○ ○





















FURNITURE

Bolt Hole - Pressed Steel, Thermoplastic Twin Wheeled Castors

Optimised Manoeuvrability

The Agila with Supratech is a twin wheel castor with high load capacity and low height. It has outstanding manoeuvrability due to it being a twin wheel castor with high-performance material.

-  **Load capacity:** 45 - 80 kg
-  **Temperature:** - 20 / + 60 °C
-  **Overall height:** 69 - 99 mm
-  **Wheel diameter:** 50 - 75 mm

	Wheel diameter [mm]	Width of Tread [mm]	Centre hole [mm]		Offset [mm]	Overall height [mm]	Load capacity [kg]		Serial number	Order number
Swivel Castors										
	50	18	11		25	69	45		1970PIO050P30-11 TUK	00603065
	75	25	13		31,4	99	80		1970PIO075P30-13 TUK	00603061
Swivel Castors with wheel brake										
	50	18	11		25	69	45		1975PIO050P30-11 TUK	00603063
										
Swivel Castors with total lock										
	75	25	13		31,4	99	80		1977PIO075P30-13 TUK	00603631
										

Technical Information

Housing made of pressed steel, bright zinc plated, blue passivated, double ball bearing swivel head, wheel axle with nut and bolt hole. Wheel centre made of Polypropylene and tread consisting of TENTEprene (thermoplastic rubber), grey non-marking, plain bearing. Other tread options available!

Advantages at a glance

Roll performance	● ● ● ○ ○
Movement noise	● ● ● ○ ○
Attrition	● ● ● ○ ○
Corrosion resistance	● ● ● ○ ○

FURNITURE

Bolt Hole - Synthetic, Thermoplastic Wheeled Castors

Durability Meets Design

The Levina with Supratech is the ideal castor for durability and design. It has extremely high shock absorbance and its soft wheel version allows for the reduction of noise. Additionally, it has been awarded an award-winning design for its distinguished appearance.

 **Load capacity:** 100 kg

 **Temperature:** - 10 / + 40 °C

 **Overall height:** 137 - 161 mm

 **Wheel diameter:** 100 - 125 mm



	Wheel diameter [mm]	Width of Tread [mm]	Centre hole [mm]		Offset [mm]	Overall height [mm]	Load capacity [kg]		Serial number	Order number
Swivel Castors	100	32	13		36	137	100		5370PJP100P30-13	00035105
	125	32	13		38	161	100		5370PJP125P30-13	00034257
Swivel Castors with total lock	100	32	13		36	137	100		5377PJP100P30-13	00601577
	125	32	13		38	161	100		5377PJP125P30-13	00034259



Technical Information

Housing and wheels made from high grade synthetic materials, double ball bearing swivel head and bolt hole. Wheel centre made of Polypropylene and tread consisting of TENTEprene (thermoplastic rubber), grey non-marking with precision ball bearing. Other tread options available!

Advantages at a glance





Roll performance	● ● ● ○ ○
Movement noise	● ● ● ● ○
Attrition	● ● ● ○ ○
Corrosion resistance	● ● ● ● ○





















































FURNITURE

Plate - Pressed Steel, Nylon Wheeled Castors

Simple & Compact

The Compacta with Duratech is perfect when moving a small load such as a drawer or side table. It is environmentally friendly and complies with RoHS and REACH regulations, as well as European Standards.

-  **Load capacity:** 10 - 40 kg
-  **Temperature:** - 20 / + 60 °C
-  **Overall height:** 17 - 36 mm
-  **Wheel diameter:** 14 - 45 mm

	Wheel diameter [mm]	Width of Tread [mm]	Size of Plate [mm]	Plate hole centres [mm]	Plate hole [mm]	Offset [mm]	Overall height [mm]	Load capacity [kg]	Serial number	Order number
Fixed Castors	 14	 14	 30 x 17	 20	 4		 17	 25	2198POI014P60-30x17	00021120
Fixed Castors	 25	 13	 40 x 17	 30	 4,5		 28	 25	2198UOI025P60-40x17	00021131
	 30	 15	 45 x 20	 35	 5,5		 34	 30	2198UOI030P60-45X20	00021134
	 45	 18	 67 x 24	 54	 5,3		 48,5	 40	2198UOI045P60-67x24	00021141
Swivel Castors	 25	 12	 35 x 30	 28 x 23	 4,2	 9	 36	 10	1430POI025P60-35x30	00021132
	 32	 14	 38 x 32	 30 x 24	 4,2	 11	 42,5	 20	1430POI032P60-38X32	00032082
	 38	 16	 46 x 38	 36 x 28	 5,3	 13	 50,5	 25	1430POI038P60-46x38	00032083

Technical Information

Fork made of pressed steel, bright zinc plated, blue passivated, axle riveted. Wheel centre made of Polyamide with plain bearing. Other tread options available!

Advantages at a glance





Roll performance	● ● ● ○ ○
Movement noise	● ● ● ○ ○
Attrition	● ● ● ● ●
Corrosion resistance	● ● ● ○ ○



























FURNITURE

Plate - Pressed Steel, Polyurethane Wheeled Castors

Environmentally Practical & User Friendly

The Aglia with Maxtech is a practical system solution with an ideal wheel material for every purpose. They are low-maintenance castors that are perfect for those that want to avoid markings on their floors.

-  **Load capacity:** 40 - 60 kg
-  **Temperature:** - 20 / + 60 °C
-  **Overall height:** 70 - 100 mm
-  **Wheel diameter:** 50 - 75 mm

	Wheel diameter [mm]	Width of Tread [mm]	Size of Plate [mm]	Plate hole centres [mm]	Plate hole [mm]	Offset [mm]	Overall height [mm]	Load capacity [kg]	Serial number	Order number
Swivel Castors										
	50	19	60 x 60	48/38 x 48/38	6,3	25	70	40	1470PAO050P40	00031108
										
	75	25	60 x 60	48/38 x 48/38	6,3	25	100	60	1470PAO075P40	00031110
Swivel Castors with wheel brake										
	50	19	60 x 60	48/38 x 48/38	6,3	25	70	40	1475PAO050P40	00031109
Swivel Castors with total lock										
	75	25	60 x 60	48/38 x 48/38	6,3	25	100	60	1477PAO075P40	00031111

Technical Information

Housing made of pressed steel, bright zinc plated, blue passivated, double ball bearing swivel head and plate fitting. Wheel centre made of Polypropylene and tread consisting of Polyurethane, plain bearing. Other tread options available!

Advantages at a glance





Roll performance	● ● ● ○ ○
Movement noise	● ● ● ○ ○
Attrition	● ● ● ● ○
Corrosion resistance	● ● ● ○ ○



FURNITURE

Plate - Pressed Steel, Plastic Wheeled Castors

Durable & Hygienic

The Aglia with Basetech is an ideal solution for those that are looking to maintain a clean environment. Due to the environmentally friendly wheel material, this castor attracts minimal amounts of dirt and can be cleaned quite easily. Additionally, it is quite durable due to its chemical-resistant components.

-  **Load capacity:** 40 kg
-  **Temperature:** - 20 / + 60 °C
-  **Overall height:** 70 mm
-  **Wheel diameter:** 50 mm

	Wheel diameter [mm]	Width of Tread [mm]	Size of Plate [mm]	Plate hole centres [mm]	Plate hole [mm]	Offset [mm]	Overall height [mm]	Load capacity [kg]	Serial number	Order number
Swivel Castors	50	18	60 x 60	48/38 x 48/38	6,3	25	70	40	1470POI050P40	00900119
										
Swivel Castors with wheel brake	50	18	60 x 60	48/38 x 48/38	6,3	25	70	40	1475POO050P40	00032400
										

Technical Information

Housing made of pressed steel, bright zinc plated, blue passivated, double ball bearing swivel head and plate fitting. Wheel centre made of Polypropylene and plain bearing. Other tread options available!

Advantages at a glance

Roll performance	● ● ● ○ ○
Movement noise	● ● ● ○ ○
Attrition	● ● ● ● ●
Corrosion resistance	● ● ● ○ ○

FURNITURE

Plate - Pressed Steel, Thermoplastic Wheeled Castors

Low Maintenance Mobility



























This Agila with Supratech is a single wheel castor that has the option to have a thread guard or not depending on your needs. The thread guard version allows for low maintenance due to less obstructions and minimal cleaning is needed.

 **Load capacity:** 40 - 100 kg

 **Temperature:** - 20 / + 60 °C

 **Overall height:** 69 - 160 mm

 **Wheel diameter:** 50 - 125 mm

	Wheel diameter [mm]	Width of Tread [mm]	Size of Plate [mm]	Plate hole centres [mm]	Plate hole [mm]	Offset [mm]	Overall height [mm]	Load capacity [kg]		Serial number	Order number
Swivel Castors											
	50	19	60 x 60	48/38 x 48/38	6,3	24	69	40		2470PJO050P40	00003887
	75	25	60 x 60	48/38 x 48/38	6,3	24	100	75		2470PJO075P40	00003357
	100	32	77 x 67	61,5/56 x 51,5/46,5	8,5	38	135	80		2470PJO100P50	00601091
	125	32	77 x 67	61,5/56 x 51,5/46,5	8,5	41	160	100		2470PJO125P50	00006129
Swivel Castors with wheel brake											
	50	19	60 x 60	48/38 x 48/38	6,3	24	69	40		2475PJO050P40	00003888
Swivel Castors with total lock											
	75	25	60 x 60	48/38 x 48/38	6,3	24	100	75		2477PJO075P40	00003359
	100	32	77 x 67	61,5/56 x 51,5/46,5	8,5	43,5	135	80		2477PJO100P50	00601090
	125	32	77 x 67	61,5/56 x 51,5/46,5	8,5	41	160	100		2477PJO125P50	00006130

Technical Information

Housing made of pressed steel, bright zinc plated, blue passivated, double ball bearing swivel head, wheel axle with nut and plate fitting. Wheel centre made of Polypropylene and tread consisting of TENTEprene (thermoplastic rubber), grey non-marking, plain bearing. Other tread options available!

Advantages at a glance

Roll performance	● ● ● ○ ○
Movement noise	● ● ● ○ ○
Attrition	● ● ● ○ ○
Corrosion resistance	● ● ● ○ ○

FURNITURE

Plate - Pressed Steel, Thermoplastic Twin Wheeled Castors

Optimised Manoeuvrability

The Agila with Supratech is a twin wheel castor with high load capacity and low height. It has outstanding manoeuvrability due to it being a twin wheel castor with high-performance material.

 **Load capacity:** 45 - 100 kg

 **Temperature:** - 20 / + 60 °C

 **Overall height:** 69 - 102 mm

 **Wheel diameter:** 50 - 75 mm

	Wheel diameter [mm]	Width of Tread [mm]	Size of Plate [mm]	Plate hole centres [mm]	Plate hole [mm]	Offset [mm]	Overall height [mm]	Load capacity [kg]	Serial number	Order number
Swivel Castors	50	18	60 x 60	48/38 x 48/38	6,3	25	69	45	1970PJO050P40 TUK	00603066
										
Swivel Castors with wheel brake	50	18	60 x 60	48/38 x 48/38	6,3	25	69	45	1975PJO050P40 TUK	00603064
										
Swivel Castors	75	25	77 x 67	61,5/56 x 51,5/46,5	8,5	28	102	100	2970PJO075P50	00600773
										
Swivel Castors with total lock	75	25	77 x 67	61,5/56 x 51,5/46,5	8,5	31,4	102	100	2977PJO075P50	00004271
										

Technical Information

Housing made of pressed steel, bright zinc plated, blue passivated, double ball bearing swivel head, wheel axle with nut and plate fitting. Wheel centre made of Polypropylene and tread consisting of TENTEprene (thermoplastic rubber), grey non-marking, plain bearing. Other tread options available!

Advantages at a glance





Roll performance	● ● ● ○ ○
Movement noise	● ● ● ○ ○
Attrition	● ● ● ● ○
Corrosion resistance	● ● ● ○ ○

















POINT OF SALE

Blind Hole - Plastic Twin Wheeled Castors

Flexible Design

The Lumina with Basetech has the ability to have flexible fitting options and different dome sizes. In return, these castors allow for a perfect transition from castor to application.

-  **Load capacity:** 40 kg
-  **Temperature:** - 10 / + 40 °C
-  **Overall height:** 56 mm
-  **Wheel diameter:** 50 mm

	Wheel diameter [mm]	Width of Tread [mm]	Castor width [mm]	Centre hole [mm]		Swivel Radius [mm]	Overall height [mm]	Load capacity [kg]		Serial number	Order number
Swivel Castors	 50	 7	 54	 8		 48	 56	 40		A520POI050L51-8	00072993
											
Swivel Castors with wheel brake	 50	 7	 54	 8		 62	 56	 40		A525POI050L51-8	00072994
											

Fitting Options:

P41



B10



S70



See Page 139-140 for more information and sizes

Technical Information

Housing made of Polypropylene with blind hole for furniture fittings. Wheel centre is made up of Polypropylene with plain bearing.

Advantages at a glance





Roll performance	● ● ● ○ ○
Movement noise	● ● ● ○ ○
Attrition	● ● ● ○ ○
Corrosion resistance	● ● ● ○ ○

















POINT OF SALE

Blind Hole - Nylon Twin Wheeled Castors (Low Height)

Low Height & Maximum Manoeuvrability

The Stylea with Duratech has a variety of fitting options and dome sizes, as well as lengths. It also has high manoeuvrability due to its twin wheels, which allow less friction when moving or adjusting direction.

-  **Load capacity:** 50 kg
-  **Temperature:** - 20 / + 60 °C
-  **Overall height:** 31 mm
-  **Wheel diameter:** 35 mm

	Wheel diameter [mm]	Width of Tread [mm]	Castor width [mm]	Centre hole [mm]		Swivel Radius [mm]	Overall height [mm]	Load capacity [kg]		Serial number	Order number
Swivel Castors	 35	 11	 52	 10		 37	 31	 50		5920UOI035L51-10 LOW	00078712
											
Swivel Castors with wheel brake	 35	 11	 52	 10		 45	 31	 50		5925UOI035L51-10 LOW	00770069
											



See Page 139-140 for more information and sizes

Technical Information

Housing is made of Polyamide with blind hole for furniture fittings, while the wheel centre consists of Polyamide with plain bearing. Other tread options available!

Advantages at a glance





Roll performance	● ● ● ○ ○
Movement noise	● ● ● ○ ○
Attrition	● ● ● ● ●
Corrosion resistance	● ● ● ● ○

POINT OF SALE

Blind Hole - Nylon Twin Wheeled Castors

Visual Integration

The Stylea with Supratech is a twin wheel castor with high manoeuvrability and load capacity. It has the ability to come in a variety of fitting, dome sizes and lengths in order to provide you with a solution that integrates perfectly into your application

-  **Load capacity:** 50 kg
-  **Temperature:** - 10 / + 40 °C
-  **Overall height:** 68 - 77 mm
-  **Wheel diameter:** 65 - 75 mm

	Wheel diameter [mm]	Width of Tread [mm]	Castor width [mm]	Centre hole [mm]	Dome-Ø [mm]	Swivel Radius [mm]	Overall height [mm]	Load capacity [kg]	Serial number	Order number
Swivel Castors	65	7	42	10	23	53	68	50	5920UJI065L51-10 DOM23 ALU	00601715
	75	8	53	10	20	62	77	50	5920UJI075L51-10 DOM20 ALU	00071016
Swivel Castors with wheel brake	65	7	42	10	23	77	68	50	5925UJI065L51-10 DOM23 ALU	00074624
	75	8	53	10	20	87	77	50	5925UJI075L51-10 DOM20 ALU	00074645



See Page 139-140 for more information and sizes

Technical Information

Housing made of Polyamide with blind hole for furniture fittings. Wheel centre made of Polyamide, while the tread consist of TENTEprene (thermoplastic rubber) with plain bearing. Other tread options available!

Advantages at a glance





Roll performance	● ● ● ○ ○
Movement noise	● ● ● ○ ○
Attrition	● ● ● ○ ○
Corrosion resistance	● ● ● ● ○



POINT OF SALE

Blind Hole - Polyurethane Twin Wheeled Castors

Complete Customisation

The Linea with Maxtech is a twin wheel castor that has a wide range of flexible fittings in various sizes, as well as different dome diameters and lengths for a perfect transition from castor to application. Additionally, you can customise the colour and even add your logo.

-  **Load capacity:** 90 - 100 kg
-  **Temperature:** - 10 / + 40 °C
-  **Overall height:** 50 - 100 mm
-  **Wheel diameter:** 50 - 100 mm

	Wheel diameter [mm]	Width of Tread [mm]	Castor width [mm]	Centre hole [mm]	Dome-Ø [mm]	Swivel Radius [mm]	Overall height [mm]	Load capacity [kg]	Serial number	Order number
Swivel Castors	50	13	47,5	10	23	40,5	50	100	5920UAP050L51-10 LOAD 9002	00603618
										
Swivel Castors	65	13.9	46	10	23	56	68	90	5920UAP065L51-10 Ral 9002	00603453
	75	15	55	10	30	65	75,5	100	5920UAP075L51-10 RAL9002	00770568
	100	20	73	11	40	88	100	100	5920UAP100L51-11 RAL9002	00079772
										
Swivel Castors with wheel brake	50	13	47,5	10	23	51	50	100	5925UAP050L51-10 LOAD 9002/7015	00603620
										
Swivel Castors with intermittend brake	65	13.9	46	10	23	67	68	90	5925UAP065L51-10 Ral 9002 BWR 7015	00603454
	75	15	55	10	30	81	75,5	100	5925UAP075L51-10 RAL9002 BWR 7015	00771092
	100	20	73	11	40	102	100	100	5925UAP100L51-11 Ral 9002	00079773
										

Other Colour Options:



Fitting Options:



See Page 139-140 for more information and sizes
Advantages at a glance

Roll performance	● ● ● ● ●
Movement noise	● ● ● ● ○
Attrition	● ● ● ● ●
Corrosion resistance	● ● ● ● ○

Technical Information

Wheel centre is made up of Polyamide with blind hole for furniture fittings. Tread consisting of Polyurethane with a precision ball bearing. Other tread options available!

POINT OF SALE

Blind Hole - Thermoplastic Wheeled Castors



Durability Meets Design

The Levina with Supratech is the ideal castor for durability and design. It has extremely high shock absorbance and its soft wheel version allows for the reduction of noise. Additionally, it has been awarded an award-winning design for its distinguished appearance.

- Load capacity:** 75 kg
- Temperature:** - 10 / + 40 °C
- Overall height:** 103 mm
- Wheel diameter:** 75 mm

	Wheel diameter [mm]	Width of Tread [mm]	Centre hole [mm]	Swivel Radius [mm]	Overall height [mm]	Load capacity [kg]	Serial number	Order number
Swivel Castors	75	25	10	64,5	103	75	5320PJP075L51-10	00602801
Swivel Castors with wheel brake	75	25	10	73	103	75	5325PJP075L51-10	00037167



See Page 139-140 for more information and sizes

Technical Information

Housing and wheels made from high grade synthetic materials, with integrated thread guards with blind hole for furniture fittings. The wheel centre is made of Polypropylene, while the tread consists of TENTEprene (thermoplastic rubber), grey non-marking, precision ball bearing, with thread guards. Other tread options available!

Advantages at a glance





Roll performance	● ● ● ○ ○
Movement noise	● ● ● ● ○
Attrition	● ● ● ○ ○
Corrosion resistance	● ● ● ● ○





















POINT OF SALE

Bolt Hole - Pressed Steel, Polyurethane Wheeled Castors

Environmentally Practical & User Friendly

The Aglia with Maxtech is a practical system solution with an ideal wheel material for every purpose. They are low-maintenance castors that are perfect for those that want to avoid markings on their floors.

-  **Load capacity:** 40 - 60 kg
-  **Temperature:** - 20 / + 60 °C
-  **Overall height:** 70 - 100 mm
-  **Wheel diameter:** 50 - 75 mm

	Wheel diameter [mm]	Width of Tread [mm]	Centre hole [mm]		Offset [mm]	Overall height [mm]	Load capacity [kg]		Serial number	Order number
Swivel Castors										
	50	19	11		25	70	40		1470PAO050P30-11	00031098
										
	75	25	11		25	100	60		1470PAO075P30-11	00031102
Swivel Castors with wheel brake										
	50	19	11		25	70	40		1475PAO050P30-11	00031099
Swivel Castors with total lock										
	75	25	11		25	100	60		1477PAO075P30-11	00031104

Technical Information

Housing made of pressed steel, bright zinc plated, blue passivated with double ball bearing swivel head and bolt hole. Wheel centre is made of Polypropylene and the tread consists of Polyurethane with plain bearing. Other tread options available!

Advantages at a glance





Roll performance	● ● ● ○ ○
Movement noise	● ● ● ○ ○
Attrition	● ● ● ● ○
Corrosion resistance	● ● ● ○ ○

POINT OF SALE

Bolt Hole - Pressed Steel, Plastic Wheeled Castors

Durable & Hygienic

The Aglia with Maxtech is a practical system solution with an ideal wheel material for every purpose. They are low-maintenance castors that are perfect for those that want to avoid markings on their floors.

-  **Load capacity:** 40 kg
-  **Temperature:** - 20 / + 60 °C
-  **Overall height:** 70 mm
-  **Wheel diameter:** 50 mm

	Wheel diameter [mm]	Width of Tread [mm]	Centre hole [mm]		Offset [mm]	Overall height [mm]	Load capacity [kg]		Serial number	Order number
Swivel Castors	50	18	11		25	70	40		1470POO050P30-11	00031100
Swivel Castors with wheel brake	50	18			25	70	40		1475POO050P30-11	00031101



Technical Information

Housing made of pressed steel, bright zinc plated, blue passivated with double ball bearing swivel head and bolt hole. Wheel centre is made of Polypropylene and the tread consists of Polyurethane with plain bearing. Other tread options available!

Advantages at a glance

Roll performance	● ● ● ○ ○
Movement noise	● ● ● ○ ○
Attrition	● ● ● ● ●
Corrosion resistance	● ● ● ○ ○

POINT OF SALE

Bolt Hole - Pressed Steel, Thermoplastic Wheeled Castors

Low Maintenance Mobility

This Agila with Supratech is a single wheel castor that has the option to have a thread guard or not depending on your needs. The thread guard version allows for low maintenance due to less obstructions and minimal cleaning is needed.

 **Load capacity:** 40 - 100 kg

 **Temperature:** - 20 / + 60 °C

 **Overall height:** 69 - 160 mm

 **Wheel diameter:** 50 - 125 mm

	Wheel diameter [mm]	Width of Tread [mm]	Centre hole [mm]	Offset [mm]	Overall height [mm]	Load capacity [kg]	Serial number	Order number
Swivel Castors	50	19	11	24	69	40	2470PJI050P30-11	00004530
Swivel Castors	75	25	11	24	100	75	2470PJO075P30-11	00003349
	100	32	13	38	135	80	2470PJO100P30-13	00005162
Swivel Castors	125	32	13	41	160	100	2470PJP125P30-13	00027435
Swivel Castors with wheel brake	50	19	11	24	69	40	2475PJO050P30-11	00003896

Technical Information

Housing made of pressed steel, bright zinc plated, blue passivated, double ball bearing swivel head, wheel axle with nut and bolt hole. Wheel centre is made of Polypropylene and the tread consists of TENTEprene (thermoplastic rubber), grey non-marking, precision ball bearing, with or without thread guards. Other tread options available!

Advantages at a glance

Roll performance	● ● ● ○ ○
Movement noise	● ● ● ○ ○
Attrition	● ● ● ○ ○
Corrosion resistance	● ● ● ○ ○

POINT OF SALE

Bolt Hole - Pressed Steel, Thermoplastic Wheeled Castors

Low Maintenance Mobility



This Agila with Supratech is a single wheel castor that has the option to have a thread guard or not depending on your needs. The thread guard version allows for low maintenance due to less obstructions and minimal cleaning is needed.

 **Load capacity:** 75 - 100 kg

 **Temperature:** - 20 / + 60 °C

 **Overall height:** 100 - 160 mm

 **Wheel diameter:** 75 - 125 mm

	Wheel diameter [mm]	Width of Tread [mm]	Centre hole [mm]		Offset [mm]	Overall height [mm]	Load capacity [kg]		Serial number	Order number
Swivel Castors with total lock 	75	25	11		24	100	75		2477PJO075P30-11	00003358
	100	32	13		43,5	135	80		2477PJO100P30-13	00005170
Swivel Castors with total lock 	125	32	13		41	160	100		2477PJP125P30-13	00603359

Technical Information

Housing made of pressed steel, bright zinc plated, blue passivated, double ball bearing swivel head, wheel axle with nut and bolt hole. Wheel centre is made of Polypropylene and the tread consists of TENTEprene (thermoplastic rubber), grey non-marking, precision ball bearing, with or without thread guards. Other tread options available!

Advantages at a glance





Roll performance	● ● ● ○ ○
Movement noise	● ● ● ○ ○
Attrition	● ● ● ○ ○
Corrosion resistance	● ● ● ○ ○





















POINT OF SALE

Bolt Hole - Pressed Steel, Thermoplastic Twin Wheeled Castors

Optimised Manoeuvrability

The Agila with Supratech is a twin wheel castor with high load capacity and low height. It has outstanding manoeuvrability due to it being a twin wheel castor with high-performance material.

-  **Load capacity:** 45 - 80 kg
-  **Temperature:** - 20 / + 60 °C
-  **Overall height:** 69 - 99 mm
-  **Wheel diameter:** 50 - 75 mm

	Wheel diameter [mm]	Width of Tread [mm]	Centre hole [mm]		Offset [mm]	Overall height [mm]	Load capacity [kg]		Serial number	Order number
Swivel Castors										
	50	18	11		25	69	45		1970PIO050P30-11 TUK	00603065
	75	25	13		31,4	99	80		1970PIO075P30-13 TUK	00603061
Swivel Castors with wheel brake										
	50	18	11		25	69	45		1975PIO050P30-11 TUK	00603063
										
Swivel Castors with total lock										
	75	25	13		31,4	99	80		1977PIO075P30-13 TUK	00603631
										

Technical Information

Housing made of pressed steel, bright zinc plated, blue passivated, double ball bearing swivel head, wheel axle with nut and bolt hole. Wheel centre made of Polypropylene and tread consisting of TENTEprene (thermoplastic rubber), grey non-marking, plain bearing. Other tread options available!

Advantages at a glance

Roll performance	● ● ● ○ ○
Movement noise	● ● ● ○ ○
Attrition	● ● ● ○ ○
Corrosion resistance	● ● ● ○ ○

POINT OF SALE

Bolt Hole - Pressed Steel, Nylon Wheeled Castors

Durable Resistance















The Alpha with Duratech is the perfect castor for those wanting less maintenance. It has abrasion-resistance tread and is durable even in cold weather. Additionally it can be easily steered and manoeuvre around bends and other obstacles.

 **Load capacity:** 150 kg

 **Temperature:** - 20 / + 60 °C

 **Overall height:** 108 - 155 mm

 **Wheel diameter:** 80 - 125 mm

	Wheel diameter [mm]	Width of Tread [mm]	Centre hole [mm]		Offset [mm]	Overall height [mm]	Load capacity [kg]		Serial number	Order number
Swivel Castors										
	80	34	13		40	108	150		3470UOO080P30-13	00007216
	100	36	13		40	128	150		3470UOO100P30-13	00005253
	125	40	13		40	155	150		3470UOO125P30-13	00005759
Swivel Castors with total lock										
	80	34	13		44,5	108	150		3477UOO080P30-13	00007217
	100	36	13		41	128	150		3477UOO100P30-13	00005760
	125	40	13		40	155	150		3477UOO125P30-13	00005761

Technical Information

Housing made of pressed steel, bright zinc plated, blue passivated, double ball bearing swivel head, wheel axle with nut and bolt hole. Wheel centre made of Polyamide and plain bearing. Other tread options available!

Advantages at a glance

Roll performance	● ● ● ○ ○
Movement noise	● ● ● ○ ○
Attrition	● ● ● ● ●
Corrosion resistance	● ● ● ○ ○

POINT OF SALE

Bolt Hole - Synthetic, Thermoplastic Wheeled Castors

Durability Meets Design

The Levina with Supratech is the ideal castor for durability and design. It has extremely high shock absorbance and its soft wheel version allows for the reduction of noise. Additionally, it has been awarded an award-winning design for its distinguished appearance.

 **Load capacity:** 100 kg

 **Temperature:** - 10 / + 40 °C

 **Overall height:** 137 - 161 mm

 **Wheel diameter:** 100 - 125 mm



	Wheel diameter [mm]	Width of Tread [mm]	Centre hole [mm]	Swivel Radius [mm]	Overall height [mm]	Load capacity [kg]	Serial number	Order number
Swivel Castors	100	32	13	86	137	100	5370PJP100P30-13	00035105
	125	32	13	100,5	161	100	5370PJP125P30-13	00034257
Swivel Castors with total lock	100	32	13	98	137	100	5377PJP100P30-13	00601577
	125	32	13	100,5	161	100	5377PJP125P30-13	00034259



Swivel Castors with total lock



Technical Information

Housing and wheels made from high grade synthetic materials, double ball bearing swivel head and bolt hole. Wheel centre made of Polypropylene and tread consisting of TENTEprene (thermoplastic rubber), grey non-marking with precision ball bearing. Other tread options available!

Advantages at a glance



Roll performance	● ● ● ○ ○
Movement noise	● ● ● ● ○
Attrition	● ● ● ○ ○
Corrosion resistance	● ● ● ● ○





















































POINT OF SALE

Plate - Pressed Steel, Nylon Wheeled Castors

Simple & Compact

The Compacta with Duratech is perfect when moving a small load such as a drawer or side table. It is environmentally friendly and complies with RoHS and REACH regulations, as well as European Standards.

-  **Load capacity:** 10 - 40 kg
-  **Temperature:** - 20 / + 60 °C
-  **Overall height:** 17 - 36 mm
-  **Wheel diameter:** 14 - 45 mm

	Wheel diameter [mm]	Width of Tread [mm]	Size of Plate [mm]	Plate hole centres [mm]	Plate hole [mm]	Offset [mm]	Overall height [mm]	Load capacity [kg]	Serial number	Order number
Fixed Castors	 14	 14	 30 x 17	 20	 4		 17	 25	2198POI014P60-30x17	00021120
Fixed Castors	 25	 13	 40 x 17	 30	 4,5		 28	 25	2198UOI025P60-40x17	00021131
	 30	 15	 45 x 20	 35	 5,5		 34	 30	2198UOI030P60-45X20	00021134
	 45	 18	 67 x 24	 54	 5,3		 48,5	 40	2198UOI045P60-67x24	00021141
Swivel Castors	 25	 12	 35 x 30	 28 x 23	 4,2	 9	 36	 10	1430POI025P60-35x30	00021132
	 32	 14	 38 x 32	 30 x 24	 4,2	 11	 42,5	 20	1430POI032P60-38X32	00032082
	 38	 16	 46 x 38	 36 x 28	 5,3	 13	 50,5	 25	1430POI038P60-46x38	00032083

Technical Information

Fork made of pressed steel, bright zinc plated, blue passivated, axle riveted. Wheel centre made of Polyamide with plain bearing. Other tread options available!

Advantages at a glance





Roll performance	● ● ● ○ ○
Movement noise	● ● ● ○ ○
Attrition	● ● ● ● ●
Corrosion resistance	● ● ● ○ ○



POINT OF SALE

Plate - Pressed Steel, Plastic Wheeled Castors

Durable & Hygienic

The Aglia with Basetech is an ideal solution for those that are looking to maintain a clean environment. Due to the environmentally friendly wheel material, this castor attracts minimal amounts of dirt and can be cleaned quite easily. Additionally, it is quite durable due to its chemical-resistant components.

-  **Load capacity:** 40 kg
-  **Temperature:** - 20 / + 60 °C
-  **Overall height:** 70 mm
-  **Wheel diameter:** 50 mm

	Wheel diameter [mm]	Width of Tread [mm]	Size of Plate [mm]	Plate hole centres [mm]	Plate hole [mm]	Offset [mm]	Overall height [mm]	Load capacity [kg]	Serial number	Order number
Swivel Castors	50	18	60 x 60	48/38 x 48/38	6,3	25	70	40	1470POI050P40	00900119
										
Swivel Castors with wheel brake	50	18	60 x 60	48/38 x 48/38	6,3	25	70	40	1475POO050P40	00032400
										

Technical Information

Housing made of pressed steel, bright zinc plated, blue passivated, double ball bearing swivel head and plate fitting. Wheel centre made of Polypropylene and plain bearing. Other tread options available!

Advantages at a glance

Roll performance	● ● ● ○ ○
Movement noise	● ● ● ○ ○
Attrition	● ● ● ● ●
Corrosion resistance	● ● ● ○ ○

POINT OF SALE

Plate - Pressed Steel, Thermoplastic Wheeled Castors

Low Maintenance Mobility



























This Agila with Supratech is a single wheel castor that has the option to have a thread guard or not depending on your needs. The thread guard version allows for low maintenance due to less obstructions and minimal cleaning is needed.

 **Load capacity:** 40 - 100 kg

 **Temperature:** - 20 / + 60 °C

 **Overall height:** 69 - 160 mm

 **Wheel diameter:** 50 - 125 mm

	Wheel diameter [mm]	Width of Tread [mm]	Size of Plate [mm]	Plate hole centres [mm]	Plate hole [mm]	Offset [mm]	Overall height [mm]	Load capacity [kg]		Serial number	Order number
Swivel Castors											
	50	19	60 x 60	48/38 x 48/38	6,3	24	69	40		2470PJO050P40	00003887
	75	25	60 x 60	48/38 x 48/38	6,3	24	100	75		2470PJO075P40	00003357
	100	32	77 x 67	61,5/56 x 51,5/46,5	8,5	38	135	80		2470PJO100P50	00601091
	125	32	77 x 67	61,5/56 x 51,5/46,5	8,5	41	160	100		2470PJO125P50	00006129
Swivel Castors with wheel brake											
	50	19	60 x 60	48/38 x 48/38	6,3	24	69	40		2475PJO050P40	00003888
Swivel Castors with total lock											
	75	25	60 x 60	48/38 x 48/38	6,3	24	100	75		2477PJO075P40	00003359
	100	32	77 x 67	61,5/56 x 51,5/46,5	8,5	43,5	135	80		2477PJO100P50	00601090
	125	32	77 x 67	61,5/56 x 51,5/46,5	8,5	41	160	100		2477PJO125P50	00006130

Technical Information

Housing made of pressed steel, bright zinc plated, blue passivated, double ball bearing swivel head, wheel axle with nut and plate fitting. Wheel centre made of Polypropylene and tread consisting of TENTEprene (thermoplastic rubber), grey non-marking, plain bearing. Other tread options available!

Advantages at a glance

Roll performance	● ● ● ○ ○
Movement noise	● ● ● ○ ○
Attrition	● ● ● ○ ○
Corrosion resistance	● ● ● ○ ○

POINT OF SALE

Plate - Pressed Steel, Thermoplastic Twin Wheeled Castors

Optimised Manoeuvrability

The Agila with Supratech is a twin wheel castor with high load capacity and low height. It has outstanding manoeuvrability due to it being a twin wheel castor with high-performance material.

 **Load capacity:** 45 - 100 kg

 **Temperature:** - 20 / + 60 °C

 **Overall height:** 69 - 102 mm

 **Wheel diameter:** 50 - 75 mm

	Wheel diameter [mm]	Width of Tread [mm]	Size of Plate [mm]	Plate hole centres [mm]	Plate hole [mm]	Offset [mm]	Overall height [mm]	Load capacity [kg]	Serial number	Order number
Swivel Castors	50	18	60 x 60	48/38 x 48/38	6,3	25	69	45	1970PJO050P40 TUK	00603066
										
Swivel Castors with wheel brake	50	18	60 x 60	48/38 x 48/38	6,3	25	69	45	1975PJO050P40 TUK	00603064
										
Swivel Castors	75	25	77 x 67	61,5/56 x 51,5/46,5	8,5	28	102	100	2970PJO075P50	00600773
										
Swivel Castors with total lock	75	25	77 x 67	61,5/56 x 51,5/46,5	8,5	31,4	102	100	2977PJO075P50	00004271
										

Technical Information

Housing made of pressed steel, bright zinc plated, blue passivated, double ball bearing swivel head, wheel axle with nut and plate fitting. Wheel centre made of Polypropylene and tread consisting of TENTEprene (thermoplastic rubber), grey non-marking, plain bearing. Other tread options available!

Advantages at a glance

Roll performance	● ● ● ○ ○
Movement noise	● ● ● ○ ○
Attrition	● ● ● ● ○
Corrosion resistance	● ● ● ○ ○

POINT OF SALE

Plate - Pressed Steel, Solid Rubber Wheeled Castors

Robust Manoeuvrability



The Alpha with Puratech has robust standard and ideal manoeuvrability due to its double ball bearing swivel head. Additionally, it is able to make non-marking movements, which is ideal for sensitive floors.

 **Load capacity:** 70 - 100 kg

 **Temperature:** - 20 / + 60 °C

 **Overall height:** 128 - 155 mm

 **Wheel diameter:** 100 - 125 mm

	Wheel diameter [mm]	Width of Tread [mm]	Size of Plate [mm]	Plate hole centres [mm]	Plate hole [mm]	Offset [mm]	Overall height [mm]	Load capacity [kg]		Serial number	Order number
Swivel Castors 	100	20	105 x 85	80/77 x 60	9	41	128	70		3370DVR100P62	00031136
	125	24	105 x 85	80/77 x 60	9	40	155	100		3370DVR125P62	00031137
Swivel Castors with total lock 	100	20	105 x 85	80/77 x 60	9	41	128	70		3377DVR100P62	00031141
	125	24	105 x 85	80/77 x 60	9	40	155	100		3377DVR125P62	00031142
Fixed Castors 	100	30	103 x 85	80/77 x 60	9		128	70		3478DVR100P62	00031987
	125	24	103 x 85	80/77 x 60	9		155	100		3478DVR125P62	00006230

Technical Information

Housing made of pressed steel, bright zinc plated, blue passivated, double ball bearing swivel head (excluding fixed version), wheel axle with nut and plate fitting. Wheel centre made of pressed steel and tread consisting of solid rubber, black, roller bearing. Other tread options available!

Advantages at a glance

Roll performance	● ● ● ○ ○
Movement noise	● ● ● ○ ○
Attrition	● ● ● ○ ○
Corrosion resistance	● ● ● ○ ○

POINT OF SALE

Plate - Pressed Steel, Solid Rubber Wheeled Castors

Ergonomically Friendly Use



























The Alpha with Puratech is the ideal solutions for those looking to optimise their roll resistance and to lighten the load for users. Additionally, the wheel tread also protects sensitive floors by preventing wheel markings.

 **Load capacity:** 70 - 100 kg

 **Temperature:** - 20 / + 60 °C

 **Overall height:** 108 - 155 mm

 **Wheel diameter:** 80 - 125 mm

	Wheel diameter [mm]	Width of Tread [mm]	Size of Plate [mm]	Plate hole centres [mm]	Plate hole [mm]	Offset [mm]	Overall height [mm]	Load capacity [kg]		Serial number	Order number
Swivel Castors											
	80	35	105 x 85	80/77 x 60	9	40	108	70		3470PIR080P62	00601233
	100	35	105 x 85	80/77 x 60	9	40	128	75		3470PIR100P62	00020692
	125	37	105 x 85	80/77 x 60	9	40	155	100		3470PIR125P62	00600579
Swivel Castors with total lock											
	80	35	105 x 85	80/77 x 60	9	44,5	108	70		3477PIR080P62	00600923
	100	35	105 x 85	80/77 x 60	9	41	128	75		3477PIR100P62	00022130
	125	37	105 x 85	80/77 x 60	9	40	155	100		3477PIR125P62	00600578
Fixed Castors											
	80	35	103 x 85	80/77 x 60	9		108	70		3478PIR080P62	00601014
	100	35	103 x 85	80/77 x 60	9		128	75		3478PIR100P62	00001242
	125	37	103 x 85	80/77 x 60	9		155	100		3478PIR125P62	00600991

Technical Information

Housing made of pressed steel, bright zinc plated, blue passivated, double ball bearing swivel head (excluding fixed version), wheel axle with nut, dust-guard and plate fitting. Wheel centre made of Polypropylene and tread consisting of solid rubber, grey non-marking, roller bearing. Other tread options available!

Advantages at a glance

Roll performance	● ● ● ○ ○
Movement noise	● ● ● ○ ○
Attrition	● ● ● ○ ○
Corrosion resistance	● ● ● ○ ○

POINT OF SALE

Plate - Pressed Steel, Nylon Wheeled Castors

Durable Resistance



























The Alpha with Duratech is the perfect castor for those wanting less maintenance. It has abrasion-resistance tread and is durable even in cold weather. Additionally it can be easily steered and manoeuvre around bends and other obstacles.

 **Load capacity:** 200 - 250 kg

 **Temperature:** - 40 / + 80 °C

 **Overall height:** 108 - 155 mm

 **Wheel diameter:** 80 - 125 mm

	Wheel diameter [mm]	Width of Tread [mm]	Size of Plate [mm]	Plate hole centres [mm]	Plate hole [mm]	Offset [mm]	Overall height [mm]	Load capacity [kg]		Serial number	Order number
Swivel Castors											
	80	34	105 x 85	80/77 x 60	9	40	108	200		3470UOO080P62	00601054
	100	36	105 x 85	80/77 x 60	9	41	128	200		3470UOR100P62	00002710
	125	40	105 x 85	80/77 x 60	9	40	155	250		3470UOR125P62	00005185
Swivel Castors with total lock											
	80	34	105 x 85	80/77 x 60	9	44,5	108	200		3477UOO080P62	00005658
	100	36	105 x 85	80/77 x 60	9	41	128	200		3477UOR100P62	00006879
	125	40	105 x 85	80/77 x 60	9	40	155	250		3477UOR125P62	00003431
Fixed Castors											
	80	34	103 x 85	80/77 x 60	9		108	200		3478UOO080P62	00005659
	100	36	103 x 85	80/77 x 60	9		128	200		3478UOR100P62	00002711
	125	40	103 x 85	80/77 x 60	9		155	250		3478UOR125P62	00003430

Technical Information

Housing made of pressed steel, bright zinc plated, blue passivated, double ball bearing swivel head (excluding fixed version), wheel axle with nut, dust-guard and plate fitting. Wheel centre made of Polyamide and plain bearing (UOO) or roller bearing (UOR). Other tread options available!

Advantages at a glance





Roll performance	● ● ● ○ ○
Movement noise	● ● ● ○ ○
Attrition	● ● ● ● ●
Corrosion resistance	● ● ● ○ ○

MEDICAL

Blind Hole - Polyurethane Twin Wheeled Castors

Complete Customisation

The Linea with Maxtech is a twin wheel castor that has a wide range of flexible fittings in various sizes, as well as different dome diameters and lengths for a perfect transition from castor to application. Additionally, you can customise the colour and even add your logo.

-  **Load capacity:** 90 - 100 kg
-  **Temperature:** - 10 / + 40 °C
-  **Overall height:** 50 - 100 mm
-  **Wheel diameter:** 50 - 100 mm

	Wheel diameter [mm]	Width of Tread [mm]	Castor width [mm]	Centre hole [mm]	Dome-Ø [mm]	Swivel Radius [mm]	Overall height [mm]	Load capacity [kg]	Serial number	Order number
Swivel Castors	50	13	47,5	10	23	40,5	50	100	5920UAP050L51-10 LOAD 9002	00603618
Swivel Castors	65	13.9	46	10	23	56	68	90	5920UAP065L51-10 Ral 9002	00603453
	75	15	55	10	30	65	75,5	100	5920UAP075L51-10 RAL9002	00770568
	100	20	73	11	40	88	100	100	5920UAP100L51-11 RAL9002	00079772
Swivel Castors with wheel brake	50	13	47,5	10	23	51	50	100	5925UAP050L51-10 LOAD 9002/7015	00603620
Swivel Castors with intermittend brake	65	13.9	46	10	23	67	68	90	5925UAP065L51-10 Ral 9002 BWR 7015	00603454
	75	15	55	10	30	81	75,5	100	5925UAP075L51-10 RAL9002 BWR 7015	00771092
	100	20	73	11	40	102	100	100	5925UAP100L51-11 Ral 9002	00079773



Other Colour Options:



Fitting Options:



See Page 139-140 for more information and sizes
[Advantages at a glance](#)

Technical Information

Wheel centre is made up of Polyamide with blind hole for furniture fittings. Tread consisting of Polyurethane with a precision ball bearing. Other tread options available!





Roll performance	● ● ● ● ●
Movement noise	● ● ● ● ○
Attrition	● ● ● ● ●
Corrosion resistance	● ● ● ● ○

MEDICAL







Blind Hole - Synthetic, Thermoplastic Wheeled Castors

Durability Meets Design

The Levina with Supratech is the ideal castor for durability and design. It has extremely high shock absorbance and its soft wheel version allows for the reduction of noise. Additionally, it has been awarded an award-winning design for its distinguished appearance.

-  **Load capacity:** 75 kg
-  **Temperature:** - 10 / + 40 °C
-  **Overall height:** 103 mm
-  **Wheel diameter:** 75 mm



Swivel Castors with wheel brake							Serial number	Order number
	75	25	10	73	103	75	5325PJP075L51-10	00037167



See Page 139-140 for more information and sizes

Technical Information

Housing and wheels made from high grade synthetic materials, with integrated thread guards with blind hole for furniture fittings. The wheel centre is made of Polypropylene, while the tread consists of TENTEprene (thermoplastic rubber), grey non-marking, precision ball bearing, with thread guards. Other tread options available!

Advantages at a glance

Roll performance	● ● ● ○ ○
Movement noise	● ● ● ● ○
Attrition	● ● ● ○ ○
Corrosion resistance	● ● ● ● ○

MEDICAL

Bolt Hole - Stainless Steel, Thermoplastic Wheeled Castors

Increased Productivity & Safety

The Agila with Supratech comes in a variety of fitting options, which allows you to choose the best solution to increase your productivity. Additionally, these castors are easy to wash, chemical resistant and particularly sturdy, especially when transporting goods.





















 **Load capacity:** 40 - 80 kg

 **Temperature:** - 20 / + 60 °C

 **Overall height:** 69 - 135 mm

 **Wheel diameter:** 50 - 100 mm



	Wheel diameter [mm]	Width of Tread [mm]	Centre hole [mm]		Offset [mm]	Overall height [mm]	Load capacity [kg]		Serial number	Order number
Swivel Castors										
	50	19	11		24	69	40		7470PJO050P30-11	00036671
	75	25	11		24	100	75		7470PJO075P30-11	00036677
	100	32	11		38	135	80		7470PJO100P30-11	00604071
										
Swivel Castors with wheel brake										
	50	19	11		24	69	40		7475PJO050P30-11	00036674
										
Swivel Castors with total lock										
	75	25	11		24	100	75		7477PJO075P30-11	00036680
	100	32	11		43,5	135	80		7477PJO100P30-11	00603170
										

Technical Information

Housing made of Stainless Steel, with double ball bearing swivel head, wheel axle with nut, brake pedal made of Polyamide, and bolt hole. The wheel centre is made of Polypropylene and the tread is made of TENTEprene (thermoplastic rubber), grey non-marking with plain bearing. Other tread options available!

Advantages at a glance

Roll performance	● ● ● ○ ○
Movement noise	● ● ● ○ ○
Attrition	● ● ● ○ ○
Corrosion resistance	● ● ● ● ●

MEDICAL

Bolt Hole - Pressed Steel, Thermoplastic Wheeled Castors

Low Maintenance Mobility

This Agila with Supratech is a single wheel castor that has the option to have a thread guard or not depending on your needs. The thread guard version allows for low maintenance due to less obstructions and minimal cleaning is needed

 **Load capacity:** 80 - 100 kg

 **Temperature:** - 20 / + 60 °C

 **Overall height:** 135 - 160 mm

 **Wheel diameter:** 100 - 125 mm

	Wheel diameter [mm]	Width of Tread [mm]	Centre hole [mm]	Offset [mm]	Overall height [mm]	Load capacity [kg]	Serial number	Order number
Swivel Castors	100	32	13	38	135	80	2470PJO100P30-13	00005162
								
Swivel Castors	100	32	13	38	135	80	2470PJO100P30-13	00005162
								
Swivel Castors	125	32	13	41	160	100	2470PJP125P30-13	00027435
								
Swivel Castors with total lock	125	32	13	41	160	100	2477PJP125P30-13	00603359
								

Technical Information

Housing made of pressed steel, bright zinc plated, blue passivated, double ball bearing swivel head, wheel axle with nut and bolt hole. Wheel centre is made of Polypropylene and the tread consists of TENTEprene (thermoplastic rubber), grey non-marking, precision ball bearing, with or without thread guards. Other tread options available!

Advantages at a glance





Roll performance	● ● ● ○ ○
Movement noise	● ● ● ○ ○
Attrition	● ● ● ○ ○
Corrosion resistance	● ● ● ○ ○





















MEDICAL

Bolt Hole - Pressed Steel, Thermoplastic Twin Wheeled Castors

Optimised Manoeuvrability

The Agila with Supratech is a twin wheel castor with high load capacity and low height. It has outstanding manoeuvrability due to it being a twin wheel castor with high-performance material.

-  **Load capacity:** 45 - 80 kg
-  **Temperature:** - 20 / + 60 °C
-  **Overall height:** 69 - 99 mm
-  **Wheel diameter:** 50 - 75 mm

	Wheel diameter [mm]	Width of Tread [mm]	Centre hole [mm]		Offset [mm]	Overall height [mm]	Load capacity [kg]		Serial number	Order number
Swivel Castors										
	50	18	11		25	69	45		1970PIO050P30-11 TUK	00603065
	75	25	13		31,4	99	80		1970PIO075P30-13 TUK	00603061
Swivel Castors with wheel brake										
	50	18	11		25	69	45		1975PIO050P30-11 TUK	00603063
										
Swivel Castors with total lock										
	75	25	13		31,4	99	80		1977PIO075P30-13 TUK	00603631
										

Technical Information

Housing made of pressed steel, bright zinc plated, blue passivated, double ball bearing swivel head, wheel axle with nut and bolt hole. Wheel centre made of Polypropylene and tread consisting of TENTEprene (thermoplastic rubber), grey non-marking, plain bearing. Other tread options available!

Advantages at a glance

Roll performance	● ● ● ○ ○
Movement noise	● ● ● ○ ○
Attrition	● ● ● ○ ○
Corrosion resistance	● ● ● ○ ○

MEDICAL

Bolt Hole - Synthetic, Thermoplastic Wheeled Castors

Durability Meets Design

The Levina with Supratech is the ideal castor for durability and design. It has extremely high shock absorbance and its soft wheel version allows for the reduction of noise. Additionally, it has been awarded an award-winning design for its distinguished appearance.

 **Load capacity:** 100 kg

 **Temperature:** - 10 / + 40 °C

 **Overall height:** 137 - 161 mm

 **Wheel diameter:** 100 - 125 mm



	Wheel diameter [mm]	Width of Tread [mm]	Centre hole [mm]		Offset [mm]	Overall height [mm]	Load capacity [kg]		Serial number	Order number
Swivel Castors	100	32	13		36	137	100		5370PJP100P30-13	00035105
	125	32	13		38	161	100		5370PJP125P30-13	00034257
Swivel Castors with total lock	100	32	13		36	137	100		5377PJP100P30-13	00601577
	125	32	13		38	161	100		5377PJP125P30-13	00034259



Technical Information

Housing and wheels made from high grade synthetic materials, double ball bearing swivel head with bolt hole. Wheel centre made of Polypropylene and tread consisting of TENTEprene (thermoplastic rubber), grey non-marking, precision ball bearing. Other tread options available!

Advantages at a glance





Roll performance	● ● ● ○ ○
Movement noise	● ● ● ● ○
Attrition	● ● ● ○ ○
Corrosion resistance	● ● ● ● ○

MEDICAL

Plate - Pressed Steel, Thermoplastic Wheeled Castors

Low Maintenance Mobility

This Agila with Supratech is a single wheel castor that has the option to have a thread guard or not depending on your needs. The thread guard version allows for low maintenance due to less obstructions and minimal cleaning is needed.

-  **Load capacity:** 80 - 100 kg
-  **Temperature:** - 20 / + 60 °C
-  **Overall height:** 135 - 160 mm
-  **Wheel diameter:** 100 - 125 mm

	Wheel diameter [mm]	Width of Tread [mm]	Size of Plate [mm]	Plate hole centres [mm]	Plate hole [mm]	Offset [mm]	Overall height [mm]	Load capacity [kg]		Serial number	Order number
Swivel Castors	100	32	77 x 67	61,5/56 x 51,5/46,5	8,5	38	135	80		2470PJO100P50	00601091
	125	32	77 x 67	61,5/56 x 51,5/46,5	8,5	41	160	100		2470PJO125P50	00006129
Swivel Castors with total lock	100	32	77 x 67	61,5/56 x 51,5/46,5	8,5	43,5	135	80		2477PJO100P50	00601090
	125	32	77 x 67	61,5/56 x 51,5/46,5	8,5	41	160	100		2477PJO125P50	00006130

Technical Information

Housing made of pressed steel, bright zinc plated, blue passivated, double ball bearing swivel head, wheel axle with nut and plate fitting. Wheel centre made of Polypropylene and tread consisting of TENTEprene (thermoplastic rubber), grey non-marking, plain bearing. Other tread options available!

Advantages at a glance





Roll performance	● ● ● ○ ○
Movement noise	● ● ● ○ ○
Attrition	● ● ● ○ ○
Corrosion resistance	● ● ● ○ ○

MEDICAL

Plate - Pressed Steel, Thermoplastic Twin Wheeled Castors

Optimised Manoeuvrability

The Agila Twin with Supratech is a twin wheel castor with high load capacity and low height. It has outstanding manoeuvrability due to it being a twin wheel castor with high-performance material.

-  **Load capacity:** 45 - 100 kg
-  **Temperature:** - 20 / + 60 °C
-  **Overall height:** 69 - 102 mm
-  **Wheel diameter:** 50 - 75 mm

	Wheel diameter [mm]	Width of Tread [mm]	Size of Plate [mm]	Plate hole centres [mm]	Plate hole [mm]	Offset [mm]	Overall height [mm]	Load capacity [kg]	Serial number	Order number
Swivel Castors	50	18	60 x 60	48/38 x 48/38	6,3	25	69	45	1970PJO050P40 TUK	00603066
										
Swivel Castors with wheel brake	50	18	60 x 60	48/38 x 48/38	6,3	25	69	45	1975PJO050P40 TUK	00603064
										
Swivel Castors	75	25	77 x 67	61,5/56 x 51,5/46,5	8,5	28	102	100	2970PJO075P50	00600773
										
Swivel Castors with total lock	75	25	77 x 67	61,5/56 x 51,5/46,5	8,5	31,4	102	100	2977PJO075P50	00004271
										

Technical Information

Housing made of pressed steel, bright zinc plated, blue passivated, double ball bearing swivel head, wheel axle with nut and plate fitting. Wheel centre made of Polypropylene and tread consisting of TENTEprene (thermoplastic rubber), grey non-marking, plain bearing. Other tread options available!

Advantages at a glance





Roll performance	● ● ● ○ ○
Movement noise	● ● ● ○ ○
Attrition	● ● ● ● ○
Corrosion resistance	● ● ● ○ ○





















HARDWARE

Bolt Hole - Pressed Steel, Polyurethane Wheeled Castors

Environmentally Practical & User Friendly

The Aglia with Maxtech is a practical system solution with an ideal wheel material for every purpose. They are low-maintenance castors that are perfect for those that want to avoid markings on their floors.

-  **Load capacity:** 40 - 60 kg
-  **Temperature:** - 20 / + 60 °C
-  **Overall height:** 70 - 100 mm
-  **Wheel diameter:** 50 - 75 mm

	Wheel diameter [mm]	Width of Tread [mm]	Centre hole [mm]		Offset [mm]	Overall height [mm]	Load capacity [kg]		Serial number	Order number
Swivel Castors										
	50	19	11		25	70	40		1470PAO050P30-11	00031098
	75	25	11		25	100	60		1470PAO075P30-11	00031102
Swivel Castors with wheel brake										
	50	19	11		25	70	40		1475PAO050P30-11	00031099
										
Swivel Castors with total lock										
	75	25	11		25	100	60		1477PAO075P30-11	00031104
										

Technical Information

Housing made of pressed steel, bright zinc plated, blue passivated with double ball bearing swivel head and bolt hole. Wheel centre is made of Polypropylene and the tread consists of Polyurethane with plain bearing. Other tread options available!

Advantages at a glance





Roll performance	● ● ● ○ ○
Movement noise	● ● ● ○ ○
Attrition	● ● ● ● ○
Corrosion resistance	● ● ● ○ ○

HARDWARE

Bolt Hole - Pressed Steel, Plastic Wheeled Castors

Durable & Hygienic

The Aglia with Maxtech is a practical system solution with an ideal wheel material for every purpose. They are low-maintenance castors that are perfect for those that want to avoid markings on their floors.

-  **Load capacity:** 40 kg
-  **Temperature:** - 20 / + 60 °C
-  **Overall height:** 70 mm
-  **Wheel diameter:** 50 mm

	Wheel diameter [mm]	Width of Tread [mm]	Centre hole [mm]		Offset [mm]	Overall height [mm]	Load capacity [kg]		Serial number	Order number
Swivel Castors	50	18	11		25	70	40		1470POO050P30-11	00031100
Swivel Castors with wheel brake	50	18			25	70	40		1475POO050P30-11	00031101



Technical Information

Housing made of pressed steel, bright zinc plated, blue passivated with double ball bearing swivel head and bolt hole. Wheel centre is made of Polypropylene and the tread consists of Polyurethane with plain bearing. Other tread options available!

Advantages at a glance





Roll performance	● ● ● ○ ○
Movement noise	● ● ● ○ ○
Attrition	● ● ● ● ●
Corrosion resistance	● ● ● ○ ○





HARDWARE

Bolt Hole - Pressed Steel, Rubber Wheeled Castors

Low Maintenance Mobility

This Agila with Supratech is a single wheel castor that has the option to have a thread guard or not depending on your needs. The thread guard version allows for low maintenance due to less obstructions and minimal cleaning is needed.

-  **Load capacity:** 40 - 75 kg
-  **Temperature:** - 20 / + 60 °C
-  **Overall height:** 69 - 100 mm
-  **Wheel diameter:** 50 - 75 mm

	Wheel diameter [mm]	Width of Tread [mm]	Centre hole [mm]	Offset [mm]	Overall height [mm]	Load capacity [kg]	Serial number	Order number
Swivel Castors	50	19	11	24	69	40	2470PJI050P30-11	00004530
								
Swivel Castors with wheel brake	50	19	11	24	69	40	2475PJO050P30-11	00003896
								
Swivel Castors	75	25	11	24	100	75	2470PJO075P30-11	00003349
								
Swivel Castors with total lock	75	25	11	24	100	75	2477PJO075P30-11	00003358
								

Technical Information

Housing made of pressed steel, bright zinc plated, blue passivated, double ball bearing swivel head, wheel axle with nut and bolt hole. Wheel centre is made of Polypropylene and the tread consists of TENTEprene (thermoplastic rubber), grey non-marking, precision ball bearing, with or without thread guards. Other tread options available!

Advantages at a glance





Roll performance	● ● ● ○ ○
Movement noise	● ● ● ○ ○
Attrition	● ● ● ○ ○
Corrosion resistance	● ● ● ○ ○

HARDWARE

Bolt Hole - Pressed Steel, Polyurethane Wheeled Castors

Compact Durability

The Agila with Novatech may be small, but it is highly durable and less maintenance. Additionally it is non-marking and suitable for sensitive floors.

-  **Load capacity:** 100 kg
-  **Temperature:** - 20 / + 60 °C
-  **Overall height:** 58 mm
-  **Wheel diameter:** 35 mm

	Wheel diameter [mm]	Width of Tread [mm]	Threaded stem [mm]		Offset [mm]	Overall height [mm]	Load capacity [kg]		Serial number	Order number
Swivel Castors	35	25	10 x 20		13,5	58	100		2470ETP035S50-M10x20	00028493



Technical Information

Swivel castor, housing made of pressed steel, bright zinc plated, blue passivated, double ball bearing swivel head, socket head cap screw, loose fitted. Wheel centre made of steel and tread consisting of Polyurethane, casted, precision ball bearing. Other tread options available!

Advantages at a glance

Roll performance	● ● ● ● ○
Movement noise	● ● ● ○ ○
Attrition	● ● ● ○ ○
Corrosion resistance	● ● ● ○ ○

HARDWARE

Bolt Hole - Pressed Steel, Elastic Rubber Wheeled Castors

Smooth, Quiet Handling

The Alpha with Elastech has the ability to protect goods that are being transported due to ability to produce a low amount of vibrations. Additionally, it has optimum manoeuvrability and can easily move around obstacles.

 **Load capacity:** 160 kg

 **Temperature:** - 20 / + 80 °C

 **Overall height:** 128 - 155 mm

 **Wheel diameter:** 100 - 125 mm

	Wheel diameter [mm]	Width of Tread [mm]	Centre hole [mm]		Offset [mm]	Overall height [mm]	Load capacity [kg]		Serial number	Order number
Swivel Castors	100	34	13		40	128	160		3470UFR100P30-13	00028243
	125	40	13		40	155	160		3470UFR125P30-13	00004858
Swivel Castors with total lock	100	34	13		41	128	160		3477UFR100P30-13	00600563
	125	40	13		40	155	160		3477UFR125P30-13	00004859



Technical Information

Housing made of pressed steel, bright zinc plated, blue passivated, double ball bearing swivel head, wheel axle with nut and bolt hole. Wheel centre made of Polyamide and tread consisting of elastic-tyre, non-marking, roller bearing. Other tread options available!

Advantages at a glance





Roll performance	● ● ● ○ ○
Movement noise	● ● ● ● ●
Attrition	● ● ● ○ ○
Corrosion resistance	● ● ● ○ ○





















































HARDWARE

Plate - Pressed Steel, Nylon Wheeled Castors

Simple & Compact

The Compacta with Duratech is perfect when moving a small load such as a drawer or side table. It is environmentally friendly and complies with RoHS and REACH regulations, as well as European Standards.

-  **Load capacity:** 10 - 40 kg
-  **Temperature:** - 20 / + 60 °C
-  **Overall height:** 17 - 36 mm
-  **Wheel diameter:** 14 - 45 mm

	Wheel diameter [mm]	Width of Tread [mm]	Size of Plate [mm]	Plate hole centres [mm]	Plate hole [mm]	Offset [mm]	Overall height [mm]	Load capacity [kg]	Serial number	Order number
Fixed Castors	 14	 14	 30 x 17	 20	 4		 17	 25	2198POI014P60-30x17	00021120
Fixed Castors	 25	 13	 40 x 17	 30	 4,5		 28	 25	2198UOI025P60-40x17	00021131
	 30	 15	 45 x 20	 35	 5,5		 34	 30	2198UOI030P60-45X20	00021134
	 45	 18	 67 x 24	 54	 5,3		 48,5	 40	2198UOI045P60-67x24	00021141
Swivel Castors	 25	 12	 35 x 30	 28 x 23	 4,2	 9	 36	 10	1430POI025P60-35x30	00021132
	 32	 14	 38 x 32	 30 x 24	 4,2	 11	 42,5	 20	1430POI032P60-38X32	00032082
	 38	 16	 46 x 38	 36 x 28	 5,3	 13	 50,5	 25	1430POI038P60-46x38	00032083

Technical Information

Fork made of pressed steel, bright zinc plated, blue passivated, axle riveted. Wheel centre made of Polyamide with plain bearing. Other tread options available!

Advantages at a glance





Roll performance	● ● ● ○ ○
Movement noise	● ● ● ○ ○
Attrition	● ● ● ● ●
Corrosion resistance	● ● ● ○ ○

HARDWARE

Plate - Pressed Steel, Polyurethane Wheeled Castors

Environmentally Practical & User Friendly

The Aglia with Maxtech is a practical system solution with an ideal wheel material for every purpose. They are low-maintenance castors that are perfect for those that want to avoid markings on their floors.

-  **Load capacity:** 40 - 60 kg
-  **Temperature:** - 20 / + 60 °C
-  **Overall height:** 70 - 100 mm
-  **Wheel diameter:** 50 - 75 mm

	Wheel diameter [mm]	Width of Tread [mm]	Size of Plate [mm]	Plate hole centres [mm]	Plate hole [mm]	Offset [mm]	Overall height [mm]	Load capacity [kg]	Serial number	Order number
Swivel Castors	50	19	60 x 60	48/38 x 48/38	6,3	25	70	40	1470PAO050P40	00031108
	75	25	60 x 60	48/38 x 48/38	6,3	25	100	60	1470PAO075P40	00031110
Swivel Castors with wheel brake	50	19	60 x 60	48/38 x 48/38	6,3	25	70	40	1475PAO050P40	00031109
Swivel Castors with total lock	75	25	60 x 60	48/38 x 48/38	6,3	25	100	60	1477PAO075P40	00031111

Technical Information

Housing made of pressed steel, bright zinc plated, blue passivated, double ball bearing swivel head and plate fitting. Wheel centre made of Polypropylene and tread consisting of Polyurethane, plain bearing. Other tread options available!

Advantages at a glance





Roll performance	● ● ● ○ ○
Movement noise	● ● ● ○ ○
Attrition	● ● ● ● ○
Corrosion resistance	● ● ● ○ ○



HARDWARE

Plate - Pressed Steel, Plastic Wheeled Castors

Durable & Hygienic

The Aglia with Basetech is an ideal solution for those that are looking to maintain a clean environment. Due to the environmentally friendly wheel material, this castor attracts minimal amounts of dirt and can be cleaned quite easily. Additionally, it is quite durable due to its chemical-resistant components.

-  **Load capacity:** 40 kg
-  **Temperature:** - 20 / + 60 °C
-  **Overall height:** 70 mm
-  **Wheel diameter:** 50 mm

	Wheel diameter [mm]	Width of Tread [mm]	Size of Plate [mm]	Plate hole centres [mm]	Plate hole [mm]	Offset [mm]	Overall height [mm]	Load capacity [kg]	Serial number	Order number
Swivel Castors	50	18	60 x 60	48/38 x 48/38	6,3	25	70	40	1470POI050P40	00900119
										
Swivel Castors with wheel brake	50	18	60 x 60	48/38 x 48/38	6,3	25	70	40	1475POO050P40	00032400
										

Technical Information

Housing made of pressed steel, bright zinc plated, blue passivated, double ball bearing swivel head and plate fitting. Wheel centre made of Polypropylene and plain bearing. Other tread options available!

Advantages at a glance





Roll performance	● ● ● ○ ○
Movement noise	● ● ● ○ ○
Attrition	● ● ● ● ●
Corrosion resistance	● ● ● ○ ○



HARDWARE

Plate - Pressed Steel, Thermoplastic Wheeled Castors

Low Maintenance Mobility

This Agila with Supratech is a single wheel castor that has the option to have a thread guard or not depending on your needs. The thread guard version allows for low maintenance due to less obstructions and minimal cleaning is needed.

-  **Load capacity:** 40 - 75 kg
-  **Temperature:** - 20 / + 60 °C
-  **Overall height:** 69 - 100 mm
-  **Wheel diameter:** 50 - 75 mm

	Wheel diameter [mm]	Width of Tread [mm]	Size of Plate [mm]	Plate hole centres [mm]	Plate hole [mm]	Offset [mm]	Overall height [mm]	Load capacity [kg]		Serial number	Order number
Swivel Castors	50	19	60 x 60	48/38 x 48/38	6,3	24	69	40		2470PIO050P40	00003887
	75	25	60 x 60	48/38 x 48/38	6,3	24	100	75		2470PIO075P40	00003357
Swivel Castors with wheel brake	50	19	60 x 60	48/38 x 48/38	6,3	24	69	40		2475PIO050P40	00003888
	75	25	60 x 60	48/38 x 48/38	6,3	24	100	75		2477PIO075P40	00003359
Swivel Castors with total lock											
											

Technical Information

Housing made of pressed steel, bright zinc plated, blue passivated, double ball bearing swivel head, wheel axle with nut and plate fitting. Wheel centre made of Polypropylene and tread consisting of TENTEprene (thermoplastic rubber), grey non-marking, plain bearing. Other tread options available!

Advantages at a glance

Roll performance	● ● ● ○ ○
Movement noise	● ● ● ○ ○
Attrition	● ● ● ○ ○
Corrosion resistance	● ● ● ○ ○

HARDWARE

Plate - Pressed Steel, Solid Rubber Wheeled Castors

Robust Manoeuvrability





































The Alpha with Puratech has robust standard and ideal manoeuvrability due to its double ball bearing swivel head. Additionally, it is able to make non-marking movements, which is ideal for sensitive floors.

 **Load capacity:** 70 - 205 kg

 **Temperature:** - 20 / + 60 °C

 **Overall height:** 128 - 240 mm

 **Wheel diameter:** 100 - 200 mm

	Wheel diameter [mm]	Width of Tread [mm]	Size of Plate [mm]	Plate hole centres [mm]	Plate hole [mm]	Offset [mm]	Overall height [mm]	Load capacity [kg]	Serial number	Order number
Swivel Castors										
	100	20	105 x 85	80/77 x 60	9	41	128	70	3370DVR100P62	00031136
	125	24	105 x 85	80/77 x 60	9	40	155	100	3370DVR125P62	00031137
	160	23	137 x 105	105 x 80/77	11	57,5	200	135	3370DVR160P63	00603614
	200	30	137 x 105	105 x 80/77	11	52,5	240	205	3370DVR200P63	00600780
	200	50	137 x 105	105 x 80/75	11	55	240	205	3470DVR200P63	00005927
Swivel Castors with total lock										
	100	20	105 x 85	80/77 x 60	9	41	128	70	3377DVR100P62	00031141
	125	24	105 x 85	80/77 x 60	9	40	155	100	3377DVR125P62	00031142
	160	23	137 x 105	105 x 80/77	11	57,5	200	135	3377DVR160P63	00031143
	200	30	137 x 105	105 x 80/77	11	52,5	240	205	3377DVR200P63	00600890
Fixed Castors										
	100	30	103 x 85	80/77 x 60	9		128	70	3478DVR100P62	00031987
	125	24	103 x 85	80/77 x 60	9		155	100	3478DVR125P62	00006230
	160	40	137 x 115	105 x 80/75	11		200	135	3478DVR160P63	00000787
	200	50	137 x 115	105 x 80/75	11		240	205	3478DVR200P63	00022458
Swivel Castors with total lock										
	200	50	137 x 105	105 x 80/75	11	55	240	205	3472DVP200P63	

Directional lock 3471

Additional Options:



00002600

Technical Information

Housing made of pressed steel, bright zinc plated, blue passivated, double ball bearing swivel head (excluding fixed version), wheel axle with nut and plate fitting. Wheel centre made of pressed steel and tread consisting of solid rubber, black, roller bearing. Other tread options available!

Advantages at a glance

Roll performance	● ● ● ○ ○
Movement noise	● ● ● ○ ○
Attrition	● ● ● ○ ○
Corrosion resistance	● ● ● ○ ○

HARDWARE

Plate - Pressed Steel, Solid Rubber Wheeled Castors

Ergonomically Friendly Use



























The Alpha with Puratech is the ideal solutions for those looking to optimise their roll resistance and to lighten the load for users. Additionally, the wheel tread also protects sensitive floors by preventing wheel markings.

 **Load capacity:** 70 - 205 kg

 **Temperature:** - 20 / + 60 °C

 **Overall height:** 108 - 240 mm

 **Wheel diameter:** 80 - 200 mm

	Wheel diameter [mm]	Width of Tread [mm]	Size of Plate [mm]	Plate hole centres [mm]	Plate hole [mm]	Offset [mm]	Overall height [mm]	Load capacity [kg]		Serial number	Order number
Swivel Castors											
	80	35	105 x 85	80/77 x 60	9	40	108	70		3470PIR080P62	00601233
	100	35	105 x 85	80/77 x 60	9	40	128	75		3470PIR100P62	00020692
	125	37	105 x 85	80/77 x 60	9	40	155	100		3470PIR125P62	00600579
	160	40	137 x 105	105 x 80/75	11	55	200	135		3470PIR160P63	00023215
	200	50	137 x 105	105 x 80/75	11	55	240	205		3470PIR200P63	00053839
Swivel Castors with total lock											
	80	35	105 x 85	80/77 x 60	9	44,5	108	70		3477PIR080P62	00600923
	100	35	105 x 85	80/77 x 60	9	41	128	75		3477PIR100P62	00022130
	125	37	105 x 85	80/77 x 60	9	40	155	100		3477PIR125P62	00600578
	160	40	137 x 105	105 x 80/75	11	60	200	135		3477PIR160P63	00053178
	200	50	137 x 105	105 x 80/75	11	55	240	205		3477PIR200P63	00600143
Fixed Castors											
	80	35	103 x 85	80/77 x 60	9		108	70		3478PIR080P62	00601014
	100	35	103 x 85	80/77 x 60	9		128	75		3478PIR100P62	00001242
	125	37	103 x 85	80/77 x 60	9		155	100		3478PIR125P62	00600991
	160	40	137 x 115	105 x 80/75	11		200	135		3478PIR160P63	00600714
	200	50	137 x 115	105 x 80/75	11		240	205		3478PIR200P63	00053651

Technical Information

Housing made of pressed steel, bright zinc plated, blue passivated, double ball bearing swivel head (excluding fixed version), wheel axle with nut, dust-guard and plate fitting. Wheel centre made of Polypropylene and tread consisting of solid rubber, grey non-marking, roller bearing. Other tread options available!

Advantages at a glance

Roll performance	● ● ● ○ ○
Movement noise	● ● ● ○ ○
Attrition	● ● ● ○ ○
Corrosion resistance	● ● ● ○ ○

HARDWARE

Plate - Pressed Steel, Elastic Rubber Wheeled Castors

Smooth, Quiet Handling



The Alpha with Elastech has the ability to protect goods that are being transported due to ability to produce a low amount of vibrations. Additionally, it has optimum manoeuvrability and can easily move around obstacles.

 **Load capacity:** 160 - 250 kg

 **Temperature:** - 20 / + 80 °C

 **Overall height:** 128 - 155 mm

 **Wheel diameter:** 100 - 125 mm

	Wheel diameter [mm]	Width of Tread [mm]	Size of Plate [mm]	Plate hole centres [mm]	Plate hole [mm]	Offset [mm]	Overall height [mm]	Load capacity [kg]	Serial number	Order number
Swivel Castors 	100	34	105 x 85	80/77 x 60	9	41	128	160	3470UFR100P62 blue	00001101
	125	40	105 x 85	80/77 x 60	9	40	155	250	3470UFR125P62 blue	00004632
Swivel Castors with total lock 	100	34	105 x 85	80/77 x 60	9	41	128	160	3477UFR100P62 blue	00001426
	125	40	105 x 85	80/77 x 60	9	40	155	250	3477UFR125P62 blue	00007002
Fixed Castors 	100	34	103 x 85	80/77 x 60	9		128	160	3478UFR100P62 blue	00004019
	125	40	103 x 85	80/77 x 60	9		155	250	3478UFR125P62 blue	00004634

Technical Information

Housing made of pressed steel, bright zinc plated, blue passivated, double ball bearing swivel head (excluding fixed version), wheel axle with nut, dust-guard and plate fitting. Wheel centre made of Polyamide and tread consisting of elastic-tyre, non-marking, roller bearing. Other tread options available!

Advantages at a glance

Roll performance	● ● ● ○ ○
Movement noise	● ● ● ● ●
Attrition	● ● ● ○ ○
Corrosion resistance	● ● ● ○ ○

HARDWARE

Plate - Pressed Steel, Elastic Rubber Wheeled Castors

Smooth, Quiet Handling

The Alpha with Elastech has the ability to protect goods that are being transported due to ability to produce a low amount of vibrations. Additionally, it has optimum manoeuvrability and can easily move around obstacles.

 **Load capacity:** 160 - 250 kg

 **Temperature:** - 20 / + 80 °C

 **Overall height:** 128 - 155 mm

 **Wheel diameter:** 100 - 125 mm

	Wheel diameter [mm]	Width of Tread [mm]	Size of Plate [mm]	Plate hole centres [mm]	Plate hole [mm]	Offset [mm]	Overall height [mm]	Load capacity [kg]	Serial number	Order number
Swivel Castors	100	34	105 x 85	80/77 x 60	9	41	128	160	3470UFR100P62	00003464
	125	40	105 x 85	80/77 x 60	9	40	155	250	3470UFR125P62	00001154
Swivel Castors with total lock	100	34	105 x 85	80/77 x 60	9	41	128	160	3477UFR100P62	00001427
	125	40	105 x 85	80/77 x 60	9	40	155	250	3477UFR125P62	00003805
Fixed Castors	100	34	103 x 85	80/77 x 60	9		128	160	3478UFR100P62	00000044
	125	40	103 x 85	80/77 x 60	9		155	250	3478UFR125P62	00026592

Technical Information

Housing made of pressed steel, bright zinc plated, blue passivated, double ball bearing swivel head (excluding fixed version), wheel axle with nut, dust-guard and plate fitting. Wheel centre made of Polyamide and tread consisting of elastic-tyre, non-marking, roller bearing. Other tread options available!

Advantages at a glance





Roll performance	● ● ● ○ ○
Movement noise	● ● ● ● ●
Attrition	● ● ● ○ ○
Corrosion resistance	● ● ● ○ ○



HARDWARE

Plate - Pressed Steel, Polyurethane Wheeled Castors

Industrial Design

The Alpha with Maxtech has a great for functional design and perfect everyday use. It is also extremely hard-wearing and can manoeuvre around easily with its double ball bearing swivel head.

-  **Load capacity:** 150 kg
-  **Temperature:** - 40 / + 80 °C
-  **Overall height:** 108 mm
-  **Wheel diameter:** 80 mm

	Wheel diameter [mm]	Width of Tread [mm]	Size of Plate [mm]	Plate hole centres [mm]	Plate hole [mm]	Offset [mm]	Overall height [mm]	Load capacity [kg]	Serial number	Order number
Swivel Castors	80	38	105 x 85	80/77 x 60	9	40	108	150	3470UAR080P62 grey	00001085
										
Swivel Castors with total lock	80	38	105 x 85	80/77 x 60	9	44,5	108	150	3477UAR080P62 grey	00001390
										
Fixed Castors	80	38	103 x 85	80/77 x 60	9		108	150	3478UAR080P62 grey	00001274
										

Technical Information

Housing made of pressed steel, bright zinc plated, blue passivated, double ball bearing swivel head (excluding fixed version), wheel axle with nut, dust-guard and plate fitting. Wheel centre made of Polyamide and tread consisting of Polyurethane, roller bearing. Other tread options available!

Advantages at a glance

Roll performance	● ● ● ○ ○
Movement noise	● ● ● ○ ○
Attrition	● ● ● ● ○
Corrosion resistance	● ● ● ○ ○

HARDWARE

Plate - Pressed Steel, Polyurethane Wheeled Castors

Industrial Design

The Alpha with Maxtech has a great for functional design and perfect everyday use. It is also extremely hard-wearing and can manoeuvre around easily with its double ball bearing swivel head.

 **Load capacity:** 150 - 200 kg

 **Temperature:** - 40 / + 80 °C

 **Overall height:** 128 - 155 mm

 **Wheel diameter:** 100 - 125 mm

	Wheel diameter [mm]	Width of Tread [mm]	Size of Plate [mm]	Plate hole centres [mm]	Plate hole [mm]	Offset [mm]	Overall height [mm]	Load capacity [kg]	Serial number	Order number
Swivel Castors	100	32	105 x 85	80/77 x 60	9	40	128	150	3470UAR100P62 red	00601009
	125	32	105 x 85	80/77 x 60	9	40	155	200	3470UAR125P62 red	00600597
Swivel Castors with total lock	100	32	105 x 85	80/77 x 60	9	41	128	150	3477UAR100P62 red	00600594
	125	32	105 x 85	80/77 x 60	9	40	155	200	3477UAR125P62 red	00600595
Fixed Castors	100	32	103 x 85	80/77 x 60	9		128	150	3478UAR100P62 red	00601010
	125	32	105 x 85	80/77 x 60	9		155	200	3478UAR125P62 red	00601001

Technical Information

Housing made of pressed steel, bright zinc plated, blue passivated, double ball bearing swivel head (excluding fixed version), wheel axle with nut, dust-guard and plate fitting. Wheel centre made of Polyamide and tread consisting of Polyurethane, roller bearing. Other tread options available!

Advantages at a glance

Roll performance	● ● ● ○ ○
Movement noise	● ● ● ○ ○
Attrition	● ● ● ● ○
Corrosion resistance	● ● ● ○ ○

DISTRIBUTION

Bolt Hole - Pressed Steel, Elastic Rubber Wheeled Castors

Smooth, Quiet Handling

The Alpha with Elastech has the ability to protect goods that are being transported due to ability to produce a low amount of vibrations. Additionally, it has optimum manoeuvrability and can easily move around obstacles.

 **Load capacity:** 160 kg

 **Temperature:** - 20 / + 80 °C

 **Overall height:** 128 - 155 mm

 **Wheel diameter:** 100 - 125 mm

	Wheel diameter [mm]	Width of Tread [mm]	Centre hole [mm]		Offset [mm]	Overall height [mm]	Load capacity [kg]		Serial number	Order number
Swivel Castors	100	34	13		40	128	160		3470UFR100P30-13	00028243
	125	40	13		40	155	160		3470UFR125P30-13	00004858
Swivel Castors with total lock	100	34	13		41	128	160		3477UFR100P30-13	00600563
	125	40	13		40	155	160		3477UFR125P30-13	00004859



Technical Information

Housing made of pressed steel, bright zinc plated, blue passivated, double ball bearing swivel head, wheel axle with nut and bolt hole. Wheel centre made of Polyamide and tread consisting of elastic-tyre, non-marking, roller bearing. Other tread options available!

Advantages at a glance

Roll performance	● ● ● ○ ○
Movement noise	● ● ● ● ●
Attrition	● ● ● ○ ○
Corrosion resistance	● ● ● ○ ○

DISTRIBUTION

Bolt Hole - Pressed Steel, Nylon Wheeled Castors

Durable Resistance















The Alpha with Duratech is the perfect castor for those wanting less maintenance. It has abrasion-resistance tread and is durable even in cold weather. Additionally it can be easily steered and manoeuvre around bends and other obstacles.

 **Load capacity:** 150 kg

 **Temperature:** - 20 / + 60 °C

 **Overall height:** 108 - 155 mm

 **Wheel diameter:** 80 - 125 mm

	Wheel diameter [mm]	Width of Tread [mm]	Centre hole [mm]		Offset [mm]	Overall height [mm]	Load capacity [kg]		Serial number	Order number
Swivel Castors										
	80	34	13		40	108	150		3470UOO080P30-13	00007216
	100	36	13		40	128	150		3470UOO100P30-13	00005253
	125	40	13		40	155	150		3470UOO125P30-13	00005759
Swivel Castors with total lock										
	80	34	13		44,5	108	150		3477UOO080P30-13	00007217
	100	36	13		41	128	150		3477UOO100P30-13	00005760
	125	40	13		40	155	150		3477UOO125P30-13	00005761

Technical Information

Housing made of pressed steel, bright zinc plated, blue passivated, double ball bearing swivel head, wheel axle with nut and bolt hole. Wheel centre made of Polyamide and plain bearing. Other tread options available!

Advantages at a glance

Roll performance	● ● ● ○ ○
Movement noise	● ● ● ○ ○
Attrition	● ● ● ● ●
Corrosion resistance	● ● ● ○ ○

DISTRIBUTION

Plate - Pressed Steel, Solid Rubber Wheeled Castors

Robust Manoeuvrability





































The Alpha with Puratech has robust standard and ideal manoeuvrability due to its double ball bearing swivel head. Additionally, it is able to make non-marking movements, which is ideal for sensitive floors.

 **Load capacity:** 70 - 205 kg

 **Temperature:** - 20 / + 60 °C

 **Overall height:** 128 - 240 mm

 **Wheel diameter:** 100 - 200 mm

	Wheel diameter [mm]	Width of Tread [mm]	Size of Plate [mm]	Plate hole centres [mm]	Plate hole [mm]	Offset [mm]	Overall height [mm]	Load capacity [kg]	Serial number	Order number
Swivel Castors										
	100	20	105 x 85	80/77 x 60	9	41	128	70	3370DVR100P62	00031136
	125	24	105 x 85	80/77 x 60	9	40	155	100	3370DVR125P62	00031137
	160	23	137 x 105	105 x 80/77	11	57,5	200	135	3370DVR160P63	00603614
	200	30	137 x 105	105 x 80/77	11	52,5	240	205	3370DVR200P63	00600780
	200	50	137 x 105	105 x 80/75	11	55	240	205	3470DVR200P63	00005927
Swivel Castors with total lock										
	100	20	105 x 85	80/77 x 60	9	41	128	70	3377DVR100P62	00031141
	125	24	105 x 85	80/77 x 60	9	40	155	100	3377DVR125P62	00031142
	160	23	137 x 105	105 x 80/77	11	57,5	200	135	3377DVR160P63	00031143
	200	30	137 x 105	105 x 80/77	11	52,5	240	205	3377DVR200P63	00600890
Fixed Castors										
	100	30	103 x 85	80/77 x 60	9		128	70	3478DVR100P62	00031987
	125	24	103 x 85	80/77 x 60	9		155	100	3478DVR125P62	00006230
	160	40	137 x 115	105 x 80/75	11		200	135	3478DVR160P63	00000787
	200	50	137 x 115	105 x 80/75	11		240	205	3478DVR200P63	00022458
Swivel Castors with total lock										
	200	50	137 x 105	105 x 80/75	11	55	240	205	3472DVP200P63	

Directional lock 3471

Additional Options:



00002600

Technical Information

Housing made of pressed steel, bright zinc plated, blue passivated, double ball bearing swivel head (excluding fixed version), wheel axle with nut and plate fitting. Wheel centre made of pressed steel and tread consisting of solid rubber, black, roller bearing. Other tread options available!

Advantages at a glance

Roll performance	● ● ● ○ ○
Movement noise	● ● ● ○ ○
Attrition	● ● ● ○ ○
Corrosion resistance	● ● ● ○ ○

DISTRIBUTION

Plate - Pressed Steel, Solid Rubber Wheeled Castors

Ergonomically Friendly Use



























The Alpha with Puratech is the ideal solutions for those looking to optimise their roll resistance and to lighten the load for users. Additionally, the wheel tread also protects sensitive floors by preventing wheel markings.

 **Load capacity:** 70 - 205 kg

 **Temperature:** - 20 / + 60 °C

 **Overall height:** 108 - 240 mm

 **Wheel diameter:** 80 - 200 mm

	Wheel diameter [mm]	Width of Tread [mm]	Size of Plate [mm]	Plate hole centres [mm]	Plate hole [mm]	Offset [mm]	Overall height [mm]	Load capacity [kg]		Serial number	Order number
Swivel Castors											
	80	35	105 x 85	80/77 x 60	9	40	108	70		3470PIR080P62	00601233
	100	35	105 x 85	80/77 x 60	9	40	128	75		3470PIR100P62	00020692
	125	37	105 x 85	80/77 x 60	9	40	155	100		3470PIR125P62	00600579
	160	40	137 x 105	105 x 80/75	11	55	200	135		3470PIR160P63	00023215
	200	50	137 x 105	105 x 80/75	11	55	240	205		3470PIR200P63	00053839
Swivel Castors with total lock											
	80	35	105 x 85	80/77 x 60	9	44,5	108	70		3477PIR080P62	00600923
	100	35	105 x 85	80/77 x 60	9	41	128	75		3477PIR100P62	00022130
	125	37	105 x 85	80/77 x 60	9	40	155	100		3477PIR125P62	00600578
	160	40	137 x 105	105 x 80/75	11	60	200	135		3477PIR160P63	00053178
	200	50	137 x 105	105 x 80/75	11	55	240	205		3477PIR200P63	00600143
Fixed Castors											
	80	35	103 x 85	80/77 x 60	9		108	70		3478PIR080P62	00601014
	100	35	103 x 85	80/77 x 60	9		128	75		3478PIR100P62	00001242
	125	37	103 x 85	80/77 x 60	9		155	100		3478PIR125P62	00600991
	160	40	137 x 115	105 x 80/75	11		200	135		3478PIR160P63	00600714
	200	50	137 x 115	105 x 80/75	11		240	205		3478PIR200P63	00053651

Technical Information

Housing made of pressed steel, bright zinc plated, blue passivated, double ball bearing swivel head (excluding fixed version), wheel axle with nut, dust-guard and plate fitting. Wheel centre made of Polypropylene and tread consisting of solid rubber, grey non-marking, roller bearing. Other tread options available!

Advantages at a glance

Roll performance	● ● ● ○ ○
Movement noise	● ● ● ○ ○
Attrition	● ● ● ○ ○
Corrosion resistance	● ● ● ○ ○

DISTRIBUTION

Plate - Pressed Steel, Elastic Rubber Wheeled Castors

Smooth, Quiet Handling



The Alpha with Elastech has the ability to protect goods that are being transported due to ability to produce a low amount of vibrations. Additionally, it has optimum manoeuvrability and can easily move around obstacles.

 **Load capacity:** 160 - 250 kg

 **Temperature:** - 20 / + 80 °C

 **Overall height:** 128 - 155 mm

 **Wheel diameter:** 100 - 125 mm

	Wheel diameter [mm]	Width of Tread [mm]	Size of Plate [mm]	Plate hole centres [mm]	Plate hole [mm]	Offset [mm]	Overall height [mm]	Load capacity [kg]	Serial number	Order number
Swivel Castors 	100	34	105 x 85	80/77 x 60	9	41	128	160	3470UFR100P62 blue	00001101
	125	40	105 x 85	80/77 x 60	9	40	155	250	3470UFR125P62 blue	00004632
Swivel Castors with total lock 	100	34	105 x 85	80/77 x 60	9	41	128	160	3477UFR100P62 blue	00001426
	125	40	105 x 85	80/77 x 60	9	40	155	250	3477UFR125P62 blue	00007002
Fixed Castors 	100	34	103 x 85	80/77 x 60	9		128	160	3478UFR100P62 blue	00004019
	125	40	103 x 85	80/77 x 60	9		155	250	3478UFR125P62 blue	00004634

Technical Information

Housing made of pressed steel, bright zinc plated, blue passivated, double ball bearing swivel head (excluding fixed version), wheel axle with nut, dust-guard and plate fitting. Wheel centre made of Polyamide and tread consisting of elastic-tyre, non-marking, roller bearing. Other tread options available!

Advantages at a glance

Roll performance	● ● ● ○ ○
Movement noise	● ● ● ● ●
Attrition	● ● ● ○ ○
Corrosion resistance	● ● ● ○ ○

DISTRIBUTION

Plate - Pressed Steel, Elastic Rubber Wheeled Castors

Smooth, Quiet Handling



























The Alpha with Elastech has the ability to protect goods that are being transported due to ability to produce a low amount of vibrations. Additionally, it has optimum manoeuvrability and can easily move around obstacles.

 **Load capacity:** 160 - 400 kg

 **Temperature:** - 20 / + 80 °C

 **Overall height:** 128 - 240 mm

 **Wheel diameter:** 100 - 200 mm

	Wheel diameter [mm]	Width of Tread [mm]	Size of Plate [mm]	Plate hole centres [mm]	Plate hole [mm]	Offset [mm]	Overall height [mm]	Load capacity [kg]	Serial number	Order number
Swivel Castors										
	100	34	105 x 85	80/77 x 60	9	41	128	160	3470UFR100P62	00003464
	125	40	105 x 85	80/77 x 60	9	40	155	250	3470UFR125P62	00001154
	160	46	137 x 105	105 x 80/75	11	55	200	300	3470UFR160P63	00603043
	200	46	137 x 105	105 x 80/75	11	55	240	400	3470UFR200P63	00005606
Swivel Castors with total lock										
	100	34	105 x 85	80/77 x 60	9	41	128	160	3477UFR100P62	00001427
	125	40	105 x 85	80/77 x 60	9	40	155	250	3477UFR125P62	00003805
	160	46	137 x 105	105 x 80/75	11	60	200	300	3477UFR160P63	00030347
	200	46	137 x 105	105 x 80/75	11	55	240	400	3477UFR200P63	00005960
Fixed Castors										
	100	34	103 x 85	80/77 x 60	9		128	160	3478UFR100P62	00000044
	125	40	103 x 85	80/77 x 60	9		155	250	3478UFR125P62	00026592
	160	46	137 x 115	105 x 80/75	11		200	300	3478UFR160P63	00050554
	200	46	137 x 115	105 x 80/75	11		240	400	3478UFR200P63	00000855

Technical Information

Housing made of pressed steel, bright zinc plated, blue passivated, double ball bearing swivel head (excluding fixed version), wheel axle with nut, dust-guard and plate fitting. Wheel centre made of Polyamide and tread consisting of elastic-tyre, non-marking, roller bearing. Other tread options available!

Advantages at a glance

Roll performance	● ● ● ○ ○
Movement noise	● ● ● ● ●
Attrition	● ● ● ○ ○
Corrosion resistance	● ● ● ○ ○

DISTRIBUTION

Plate - Pressed Steel, Nylon Wheeled Castors

Durable Resistance



























The Alpha with Duratech is the perfect castor for those wanting less maintenance. It has abrasion-resistance tread and is durable even in cold weather. Additionally it can be easily steered and manoeuvre around bends and other obstacles.

 **Load capacity:** 200 - 350 kg

 **Temperature:** - 40 / + 80 °C

 **Overall height:** 108 - 240 mm

 **Wheel diameter:** 80 - 200 mm

	Wheel diameter [mm]	Width of Tread [mm]	Size of Plate [mm]	Plate hole centres [mm]	Plate hole [mm]	Offset [mm]	Overall height [mm]	Load capacity [kg]		Serial number	Order number
Swivel Castors											
	80	34	105 x 85	80/77 x 60	9	40	108	200		3470UOO080P62	00601054
	100	36	105 x 85	80/77 x 60	9	41	128	200		3470UOR100P62	00002710
	125	40	105 x 85	80/77 x 60	9	40	155	250		3470UOR125P62	00005185
	160	40	137 x 105	105 x 80/75	11	55	200	350		3470UOR160P63	00029874
	200	50	137 x 105	105 x 80/75	11	55	240	350		3470UOR200P63	00029868
Swivel Castors with total lock											
	80	34	105 x 85	80/77 x 60	9	44,5	108	200		3477UOO080P62	00005658
	100	36	105 x 85	80/77 x 60	9	41	128	200		3477UOR100P62	00006879
	125	40	105 x 85	80/77 x 60	9	40	155	250		3477UOR125P62	00003431
	160	40	137 x 105	105 x 80/75	11	60	200	350		3477UOR160P63	00029866
	200	50	137 x 105	105 x 80/75	11	55	240	350		3477UOR200P63	00029853
Fixed Castors											
	80	34	103 x 85	80/77 x 60	9		108	200		3478UOO080P62	00005659
	100	36	103 x 85	80/77 x 60	9		128	200		3478UOR100P62	00002711
	125	40	103 x 85	80/77 x 60	9		155	250		3478UOR125P62	00003430
	160	40	137 x 115	105 x 80/75	11		200	350		3478UOR160P63	00004875
	200	50	137 x 115	105 x 80/75	11		240	350		3478UOR200P63	00003029

Technical Information

Housing made of pressed steel, bright zinc plated, blue passivated, double ball bearing swivel head (excluding fixed version), wheel axle with nut, dust-guard and plate fitting. Wheel centre made of Polyamide and plain bearing (UOO) or roller bearing (UOR). Other tread options available!

Advantages at a glance





Roll performance	● ● ● ○ ○
Movement noise	● ● ● ○ ○
Attrition	● ● ● ● ●
Corrosion resistance	● ● ● ○ ○



DISTRIBUTION

Plate - Pressed Steel, Polyurethane Wheeled Castors

Industrial Design

The Alpha with Maxtech has a great for functional design and perfect everyday use. It is also extremely hard-wearing and can manoeuvre around easily with its double ball bearing swivel head.

-  **Load capacity:** 150 kg
-  **Temperature:** - 40 / + 80 °C
-  **Overall height:** 108 mm
-  **Wheel diameter:** 80 mm

	Wheel diameter [mm]	Width of Tread [mm]	Size of Plate [mm]	Plate hole centres [mm]	Plate hole [mm]	Offset [mm]	Overall height [mm]	Load capacity [kg]	Serial number	Order number
Swivel Castors	80	38	105 x 85	80/77 x 60	9	40	108	150	3470UAR080P62 grey	00001085
										
Swivel Castors with total lock	80	38	105 x 85	80/77 x 60	9	44,5	108	150	3477UAR080P62 grey	00001390
										
Fixed Castors	80	38	103 x 85	80/77 x 60	9		108	150	3478UAR080P62 grey	00001274
										

Technical Information

Housing made of pressed steel, bright zinc plated, blue passivated, double ball bearing swivel head (excluding fixed version), wheel axle with nut, dust-guard and plate fitting. Wheel centre made of Polyamide and tread consisting of Polyurethane, roller bearing. Other tread options available!

Advantages at a glance

Roll performance	● ● ● ○ ○
Movement noise	● ● ● ○ ○
Attrition	● ● ● ● ○
Corrosion resistance	● ● ● ○ ○

DISTRIBUTION

Plate - Pressed Steel, Polyurethane Wheeled Castors

Industrial Design



























The Alpha with Maxtech has a great for functional design and perfect everyday use. It is also extremely hard-wearing and can manoeuvre around easily with its double ball bearing swivel head.

 **Load capacity:** 150 - 350 kg

 **Temperature:** - 40 / + 80 °C

 **Overall height:** 128 - 240 mm

 **Wheel diameter:** 100 - 200 mm

	Wheel diameter [mm]	Width of Tread [mm]	Size of Plate [mm]	Plate hole centres [mm]	Plate hole [mm]	Offset [mm]	Overall height [mm]	Load capacity [kg]		Serial number	Order number
Swivel Castors											
	100	32	105 x 85	80/77 x 60	9	40	128	150		3470UAR100P62 red	00601009
	125	32	105 x 85	80/77 x 60	9	40	155	200		3470UAR125P62 red	00600597
	160	40	137 x 105	105 x 80/75	11	55	200	350		3470UAR160P63 red	00029633
	200	46	137 x 105	105 x 80/75	11	55	240	350		3470UAR200P63 red	00600946
Swivel Castors with total lock											
	100	32	105 x 85	80/77 x 60	9	41	128	150		3477UAR100P62 red	00600594
	125	32	105 x 85	80/77 x 60	9	40	155	200		3477UAR125P62 red	00600595
	160	40	137 x 105	105 x 80/75	11	60	200	350		3477UAR160P63 red	00030302
	200	46	137 x 105	105 x 80/75	11	55	240	350		3477UAR200P63 red	00600675
Fixed Castors											
	100	32	103 x 85	80/77 x 60	9		128	150		3478UAR100P62 red	00601010
	125	32	105 x 85	80/77 x 60	9		155	200		3478UAR125P62 red	00601001
	160	40	137 x 115	105 x 80/75	11		200	350		3478UAR160P63 red	00029638
	200	46	137 x 115	105 x 80/75	11		240	350		3478UAR200P63 red	00600947

Technical Information

Housing made of pressed steel, bright zinc plated, blue passivated, double ball bearing swivel head (excluding fixed version), wheel axle with nut, dust-guard and plate fitting. Wheel centre made of Polyamide and tread consisting of Polyurethane, roller bearing. Other tread options available!

Advantages at a glance

Roll performance	● ● ● ○ ○
Movement noise	● ● ● ○ ○
Attrition	● ● ● ● ○
Corrosion resistance	● ● ● ○ ○

DISTRIBUTION

Plate - Pressed Steel, Vulcanized Elastic Wheeled Castors

Easy Handling & Less Noise



The Delta with Elastech has some of the smoothest handling properties and can easily navigate around obstacles. Additionally this castor prevents vibrations and reduces noise emission.

 **Load capacity:** 300 - 450 kg

 **Temperature:** - 20 / + 85 °C

 **Overall height:** 178 - 250 mm

 **Wheel diameter:** 125 - 200 mm

	Wheel diameter [mm]	Width of Tread [mm]	Size of Plate [mm]	Plate hole centres [mm]	Plate hole [mm]	Offset [mm]	Overall height [mm]	Load capacity [kg]		Serial number	Order number
Swivel Castors 	125	50	137 x 105	105 x 80/75	11	55	178	300		3640IEP125P63	00033538
	160	50	137 x 105	105 x 80/75	11	55	210	350		3640IEP160P63	00033540
	200	50	137 x 105	105 x 80/75	11	55	250	450		3640IEP200P63	00033546
Swivel Castors with total lock 	125	50	137 x 105	105 x 80/75	11	55	178	300		3642IEP125P63	00602846
	160	50	137 x 105	105 x 80/75	11	55	210	350		3642IEP160P63	00833692
	200	50	137 x 105	105 x 80/75	11	55	250	450		3642IEP200P63	00033705
Fixed Castors 	125	50	137 x 115	105 x 80/75	11		178	300		3648IEP125P63	00033574
	160	50	137 x 115	105 x 80/75	11		210	350		3648IEP160P63	00833575
	200	50	137 x 115	105 x 80/75	11		250	450		3648IEP200P63	00033576

Technical Information

Housing made of heavy pressed steel, bright zinc plated, blue passivated, precision ball bearing swivel head (excluding fixed version), sealed, wheel axle with nut and plate fitting. Wheel centre made of Aluminium and tread consisting of black elastic-tyre, vulcanised, precision ball bearing. Other tread options available!

Advantages at a glance

Roll performance	● ● ● ○ ○
Movement noise	● ● ● ○ ○
Attrition	● ● ● ○ ○
Corrosion resistance	● ● ● ○ ○

DISTRIBUTION

Plate - Reinforced Pressed Steel, Polyurethane Casted Castors

High Load Capacity & Durability



The Zeta with Novatech has automatic alignment when picked up and an optimised roll resistance to lighten the load for the user. Additionally, the housing is made of extra heavy steel for a high capacity load.

 **Load capacity:** 500 - 800 kg

 **Temperature:** - 20 / + 60 °C

 **Overall height:** 164 - 240 mm

 **Wheel diameter:** 125 - 200 mm

	Wheel diameter [mm]	Width of Tread [mm]	Size of Plate [mm]	Plate hole centres [mm]	Plate hole [mm]	Offset [mm]	Overall height [mm]	Load capacity [kg]	Serial number	Order number
Swivel Castors 	125	50	137 x 105	105 x 80/75	11	55	164	500	4680ITP125P63 Flat	00600967
	160	50	137 x 105	105 x 80/75	11	55	200	800	4680ITP160P63 Flat	00003826
	200	50	137 x 105	105 x 80/75	11	55	240	800	4680ITP200P63 Flat	00004217
Swivel Castors with total lock 	125	50	137 x 105	105 x 80/75	11	60	164	500	4687ITP125P63 Flat	00600968
	160	50	137 x 105	105 x 80/75	11	55	200	800	4687ITP160P63 Flat	00600915
	200	50	137 x 105	105 x 80/75	11	55	240	800	4687ITP200P63 Flat	00601239
Fixed Castors 	125	50	137 x 117	105 x 80/75	11		164	500	4688ITP125P63 Flat	00600631
	160	50	137 x 117	105 x 80/75	11		200	800	4688ITP160P63 Flat	00600702
	200	50	137 x 117	105 x 80/75	11		240	800	4688ITP200P63 Flat	00601238

Other Versions Of Polyurethane Wheels:



Ultratech Shore 92



Ultratech Hydro Shore 92



Ultratech Hydro Shore 92



Ultratech Shore 92



Ultratech Soft Shore 75

Technical Information

Housing made of very heavy pressed steel, reinforced, bright zinc plated, blue passivated, sealed swivel double ball bearing, reinforced and heat-treated ball covers, riveted king pin, dust ring with integrated grease nipple, wheel axle with nut, plate fitting. Wheel centre made of Aluminium and tread consisting of Polyurethane, casted, precision ball bearing. Other tread options available!

Advantages at a glance

Roll performance	● ● ● ○ ○
Movement noise	● ● ● ○ ○
Attrition	● ● ● ● ○
Corrosion resistance	● ● ● ○ ○

FOOD & CATERING

Bolt Hole - Stainless Steel, Thermoplastic Wheeled Castors

Increased Productivity & Safety

The Agila with Supratech comes in a variety of fitting options, which allows you to choose the best solution to increase your productivity. Additionally, these castors are easy to wash, chemical resistant and particularly sturdy, especially when transporting goods.





















 **Load capacity:** 40 - 80 kg

 **Temperature:** - 20 / + 60 °C

 **Overall height:** 69 - 135 mm

 **Wheel diameter:** 50 - 100 mm



	Wheel diameter [mm]	Width of Tread [mm]	Centre hole [mm]		Offset [mm]	Overall height [mm]	Load capacity [kg]		Serial number	Order number
Swivel Castors										
	50	19	11		24	69	40		7470PJO050P30-11	00036671
	75	25	11		24	100	75		7470PJO075P30-11	00036677
	100	32	11		38	135	80		7470PJO100P30-11	00604071
										
Swivel Castors with wheel brake										
	50	19	11		24	69	40		7475PJO050P30-11	00036674
										
Swivel Castors with total lock										
	75	25	11		24	100	75		7477PJO075P30-11	00036680
	100	32	11		43,5	135	80		7477PJO100P30-11	00603170
										

Technical Information

Housing made of Stainless Steel, with double ball bearing swivel head, wheel axle with nut, brake pedal made of Polyamide, and bolt hole. The wheel centre is made of Polypropylene and the tread is made of TENTEprene (thermoplastic rubber), grey non-marking with plain bearing. Other tread options available!

Advantages at a glance

Roll performance	● ● ● ○ ○
Movement noise	● ● ● ○ ○
Attrition	● ● ● ○ ○
Corrosion resistance	● ● ● ● ●

FOOD & CATERING

Bolt Hole - Pressed Steel, Thermoplastic Wheeled Castors

Low Maintenance Mobility





This Agila with Supratech is a single wheel castor that has the option to have a thread guard or not depending on your needs. The thread guard version allows for low maintenance due to less obstructions and minimal cleaning is needed.

 **Load capacity:** 80 - 100 kg

 **Temperature:** - 20 / + 60 °C

 **Overall height:** 135 - 160 mm

 **Wheel diameter:** 100 - 125 mm

	Wheel diameter [mm]	Width of Tread [mm]	Centre hole [mm]		Offset [mm]	Overall height [mm]	Load capacity [kg]		Serial number	Order number
Swivel Castors	100	32	13		38	135	80		2470PJO100P30-13	00005162
										
Swivel Castors	100	32	13		38	135	80		2470PJO100P30-13	00005162
										
Swivel Castors	125	32	13		41	160	100		2470PJP125P30-13	00027435
										
Swivel Castors with total lock	125	32	13		41	160	100		2477PJP125P30-13	00603359
										

Technical Information

Housing made of pressed steel, bright zinc plated, blue passivated, double ball bearing swivel head, wheel axle with nut and bolt hole. Wheel centre is made of Polypropylene and the tread consists of TENTEprene (thermoplastic rubber), grey non-marking, precision ball bearing, with or without thread guards. Other tread options available!

Advantages at a glance

Roll performance	● ● ● ○ ○
Movement noise	● ● ● ○ ○
Attrition	● ● ● ○ ○
Corrosion resistance	● ● ● ○ ○

FOOD & CATERING

Bolt Hole - Pressed Steel, Nylon Wheeled Castors

Durable Resistance















The Alpha with Duratech is the perfect castor for those wanting less maintenance. It has abrasion-resistance tread and is durable even in cold weather. Additionally it can be easily steered and manoeuvre around bends and other obstacles.

 **Load capacity:** 150 kg

 **Temperature:** - 20 / + 60 °C

 **Overall height:** 108 - 155 mm

 **Wheel diameter:** 80 - 125 mm

	Wheel diameter [mm]	Width of Tread [mm]	Centre hole [mm]		Offset [mm]	Overall height [mm]	Load capacity [kg]		Serial number	Order number
Swivel Castors										
	80	34	13		40	108	150		3470UOO080P30-13	00007216
	100	36	13		40	128	150		3470UOO100P30-13	00005253
	125	40	13		40	155	150		3470UOO125P30-13	00005759
Swivel Castors with total lock										
	80	34	13		44,5	108	150		3477UOO080P30-13	00007217
	100	36	13		41	128	150		3477UOO100P30-13	00005760
	125	40	13		40	155	150		3477UOO125P30-13	00005761

Technical Information

Housing made of pressed steel, bright zinc plated, blue passivated, double ball bearing swivel head, wheel axle with nut and bolt hole. Wheel centre made of Polyamide and plain bearing. Other tread options available!

Advantages at a glance

Roll performance	● ● ● ○ ○
Movement noise	● ● ● ○ ○
Attrition	● ● ● ● ●
Corrosion resistance	● ● ● ○ ○

FOOD & CATERING

Bolt Hole - Pressed Steel, Elastic Rubber Wheeled Castors

Smooth, Quiet Handling

The Alpha with Elastech has the ability to protect goods that are being transported due to ability to produce a low amount of vibrations. Additionally, it has optimum manoeuvrability and can easily move around obstacles.

 **Load capacity:** 160 kg

 **Temperature:** - 20 / + 80 °C

 **Overall height:** 128 - 155 mm

 **Wheel diameter:** 100 - 125 mm

	Wheel diameter [mm]	Width of Tread [mm]	Centre hole [mm]		Offset [mm]	Overall height [mm]	Load capacity [kg]		Serial number	Order number
Swivel Castors	100	34	13		40	128	160		3470UFR100P30-13	00028243
	125	40	13		40	155	160		3470UFR125P30-13	00004858
Swivel Castors with total lock	100	34	13		41	128	160		3477UFR100P30-13	00600563
	125	40	13		40	155	160		3477UFR125P30-13	00004859



Technical Information

Housing made of pressed steel, bright zinc plated, blue passivated, double ball bearing swivel head, wheel axle with nut and bolt hole. Wheel centre made of Polyamide and tread consisting of elastic-tyre, non-marking, roller bearing. Other tread options available!

Advantages at a glance

Roll performance	● ● ● ○ ○
Movement noise	● ● ● ● ●
Attrition	● ● ● ○ ○
Corrosion resistance	● ● ● ○ ○

FOOD & CATERING

Bolt Hole - Synthetic, Thermoplastic Wheeled Castors

Durability Meets Design

The Levina with Supratech is the ideal castor for durability and design. It has extremely high shock absorbance and its soft wheel version allows for the reduction of noise. Additionally, it has been awarded an award-winning design for its distinguished appearance.

 **Load capacity:** 100 kg

 **Temperature:** - 10 / + 40 °C

 **Overall height:** 137 - 161 mm

 **Wheel diameter:** 100 - 125 mm



	Wheel diameter [mm]	Width of Tread [mm]	Centre hole [mm]		Offset [mm]	Overall height [mm]	Load capacity [kg]		Serial number	Order number
Swivel Castors	100	32	13		36	137	100		5370PJP100P30-13	00035105
	125	32	13		38	161	100		5370PJP125P30-13	00034257
Swivel Castors with total lock	100	32	13		36	137	100		5377PJP100P30-13	00601577
	125	32	13		38	161	100		5377PJP125P30-13	00034259



Technical Information

Housing and wheels made from high grade synthetic materials, double ball bearing swivel head and bolt hole. Wheel centre made of Polypropylene and tread consisting of TENTEprene (thermoplastic rubber), grey non-marking with precision ball bearing. Other tread options available!

Advantages at a glance

Roll performance	● ● ● ○ ○
Movement noise	● ● ● ● ○
Attrition	● ● ● ○ ○
Corrosion resistance	● ● ● ● ○

FOOD & CATERING

Plate - Stainless Steel, Nylon Wheeled Castors

Stainless Steel Resistance

The Alpha with Duratech is ideal for those needing a stainless steel option. The stainless steel housing allows for a very high resistance to a variety of items, such as water and humidity as well as various acids, fats and strong cleaning agents.



























 **Load capacity:** 200 - 500 kg

 **Temperature:** - 40 / + 80 °C

 **Overall height:** 108 - 240 mm

 **Wheel diameter:** 80 - 200 mm



	Wheel diameter [mm]	Width of Tread [mm]	Size of Plate [mm]	Plate hole centres [mm]	Plate hole [mm]	Offset [mm]	Overall height [mm]	Load capacity [kg]	Serial number	Order number
Swivel Castors										
	80	34	105 x 85	80/77 x 60	9	44,5	108	200	8470UOO080P62	00005866
	100	36	105 x 85	80/77 x 60	9	41	128	200	8470UOO100P62	00600147
	125	40	105 x 85	80/77 x 60	9	40	155	250	8470UOO125P62	00600907
	160	40	137 x 105	105 x 80/75	11	55	200	500	8470UOO160P63	00601034
	200	50	137 x 105	105 x 80/75	11	55	240	500	8470UOO200P63	00600494
Swivel Castors with total lock										
	80	34	105 x 85	80/77 x 60	9	44,5	108	200	8477UOO080P62	00006007
	100	36	105 x 85	80/77 x 60	9	41	128	200	8477UOO100P62	00601032
	125	40	105 x 85	80/77 x 60	9	40	155	200	8477UOO125P62	00026018
	160	40	137 x 105	105 x 80/75	11	60	200	500	8477UOO160P63	00025938
	200	50	137 x 105	105 x 80/75	11	55	240	500	8477UOO200P63	00026019
Fixed Castors										
	80	34	100 x 85	80/77 x 60	9		108	200	8478UOO080P62	00600944
	100	36	100 x 85	80/77 x 60	9		128	200	8478UOO100P62	00601226
	125	40	100 x 85	80/77 x 60	9		155	250	8478UOO125P62	00600495
	160	40	137 x 115	105 x 80/75	11		200	500	8478UOO160P63	00022560
	200	50	137 x 115	105 x 80/75	11		240	500	8478UOO200P63	00026021

Technical Information

Housing made of Stainless Steel, double ball bearing swivel head (excluding fixed version), wheel axle with nut, plate fitting. Wheel centre made of Polyamide, plain bearing

Advantages at a glance





Roll performance	● ● ● ○ ○
Movement noise	● ● ● ○ ○
Attrition	● ● ● ● ●
Corrosion resistance	● ● ● ● ●



























FOOD & CATERING

Plate - Pressed Steel, Nylon Wheeled Castors

Durable Resistance

The Alpha with Duratech is the perfect castor for those wanting less maintenance. It has abrasion-resistance tread and is durable even in cold weather. Additionally it can be easily steered and manoeuvre around bends and other obstacles.

-  **Load capacity:** 200 - 350 kg
-  **Temperature:** - 40 / + 80 °C
-  **Overall height:** 108 - 240 mm
-  **Wheel diameter:** 80 - 200 mm

	Wheel diameter [mm]	Width of Tread [mm]	Size of Plate [mm]	Plate hole centres [mm]	Plate hole [mm]	Offset [mm]	Overall height [mm]	Load capacity [kg]		Serial number	Order number
Swivel Castors											
	80	34	105 x 85	80/77 x 60	9	40	108	200		3470UOO080P62	00601054
	100	36	105 x 85	80/77 x 60	9	41	128	200		3470UOR100P62	00002710
	125	40	105 x 85	80/77 x 60	9	40	155	250		3470UOR125P62	00005185
	160	40	137 x 105	105 x 80/75	11	55	200	350		3470UOR160P63	00029874
	200	50	137 x 105	105 x 80/75	11	55	240	350		3470UOR200P63	00029868
Swivel Castors with total lock											
	80	34	105 x 85	80/77 x 60	9	44,5	108	200		3477UOO080P62	00005658
	100	36	105 x 85	80/77 x 60	9	41	128	200		3477UOR100P62	00006879
	125	40	105 x 85	80/77 x 60	9	40	155	250		3477UOR125P62	00003431
	160	40	137 x 105	105 x 80/75	11	60	200	350		3477UOR160P63	00029866
	200	50	137 x 105	105 x 80/75	11	55	240	350		3477UOR200P63	00029853
Fixed Castors											
	80	34	103 x 85	80/77 x 60	9		108	200		3478UOO080P62	00005659
	100	36	103 x 85	80/77 x 60	9		128	200		3478UOR100P62	00002711
	125	40	103 x 85	80/77 x 60	9		155	250		3478UOR125P62	00003430
	160	40	137 x 115	105 x 80/75	11		200	350		3478UOR160P63	00004875
	200	50	137 x 115	105 x 80/75	11		240	350		3478UOR200P63	00003029

Technical Information

Housing made of pressed steel, bright zinc plated, blue passivated, double ball bearing swivel head (excluding fixed version), wheel axle with nut, dust-guard and plate fitting. Wheel centre made of Polyamide and plain bearing (UOO) or roller bearing (UOR). Other tread options available!

Advantages at a glance

Roll performance	● ● ● ○ ○
Movement noise	● ● ● ○ ○
Attrition	● ● ● ● ●
Corrosion resistance	● ● ● ○ ○

FOOD & CATERING

Plate - Pressed Steel, Thermoplastic Wheeled Castors

Low Maintenance Mobility

This Agila with Supratech is a single wheel castor that has the option to have a thread guard or not depending on your needs. The thread guard version allows for low maintenance due to less obstructions and minimal cleaning is needed.

 **Load capacity:** 80 - 100 kg

 **Temperature:** - 20 / + 60 °C

 **Overall height:** 135 - 160 mm

 **Wheel diameter:** 100 - 125 mm

	Wheel diameter [mm]	Width of Tread [mm]	Size of Plate [mm]	Plate hole centres [mm]	Plate hole [mm]	Offset [mm]	Overall height [mm]	Load capacity [kg]	Serial number	Order number
Swivel Castors	100	32	77 x 67	61,5/56 x 51,5/46,5	8,5	38	135	80	2470PJO100P50	00601091
	125	32	77 x 67	61,5/56 x 51,5/46,5	8,5	41	160	100	2470PJO125P50	00006129
Swivel Castors with total lock	100	32	77 x 67	61,5/56 x 51,5/46,5	8,5	43,5	135	80	2477PJO100P50	00601090
	125	32	77 x 67	61,5/56 x 51,5/46,5	8,5	41	160	100	2477PJO125P50	00006130



Technical Information

Housing made of pressed steel, bright zinc plated, blue passivated, double ball bearing swivel head, wheel axle with nut and plate fitting. Wheel centre made of Polypropylene and tread consisting of TENTEprene (thermoplastic rubber), grey non-marking, plain bearing. Other tread options available!

Advantages at a glance





Roll performance	● ● ● ○ ○
Movement noise	● ● ● ○ ○
Attrition	● ● ● ○ ○
Corrosion resistance	● ● ● ○ ○



FOOD & CATERING

Plate - Pressed Steel, Heat Resistant Synthetic Wheeled Castors

Durable, Heat Resistance

The Alpha with Duratech heat is the perfect solution for those working in temperatures that range from -40° to +280°. Additionally, it has optimum manoeuvrability and can easily move around obstacles.

-  **Load capacity:** 125 - 150 kg
-  **Temperature:** - 40 / + 280 °C
-  **Overall height:** 128 mm
-  **Wheel diameter:** 100 mm

	Wheel diameter [mm]	Width of Tread [mm]	Size of Plate [mm]	Plate hole centres [mm]	Plate hole [mm]	Offset [mm]	Overall height [mm]	Load capacity [kg]	Serial number	Order number
Swivel Castors	100	35	105 x 85	80/77 x 60	9	41	128	125	3470BOG100P62 TUK	00602549
										
Fixed Castors	100	35	103 x 85	80/77 x 60	9		128	150	3478BOG100P62 TUK	00602517
										

Technical Information

Housing made of pressed steel, bright zinc plated, blue passivated, double ball bearing swivel head (excluding fixed), wheel axle with nut, dustguard, plate fitting. Wheel made of heat resisting synthetic material, self-lubricating bushing.

Advantages at a glance

Roll performance	● ● ● ● ○
Movement noise	● ● ● ○ ○
Attrition	● ● ● ● ●
Corrosion resistance	● ● ● ● ●

FOOD & CATERING

Plate - Stainless Steel, Heat Resistant Synthetic Wheeled Castors

Durable, Heat Resistance

The Alpha with Duratech heat is the perfect solution for those working in temperatures that range from -40° to +280°. Additionally, the stainless steel version can accommodate for strict hygiene regulations and it also highly resistance to many environmental factors including water, grease, fats and cleaning agents.



 **Load capacity:** 125 kg

 **Temperature:** - 40 / + 280 °C

 **Overall height:** 128 mm

 **Wheel diameter:** 100 mm



	Wheel diameter [mm]	Width of Tread [mm]	Size of Plate [mm]	Plate hole centres [mm]	Plate hole [mm]	Offset [mm]	Overall height [mm]	Load capacity [kg]	Serial number	Order number
Swivel Castors	100	35	105 x 85	80/77 x 60	9	41	128	125	8470BOG100P62	00601576
										
Fixed Castors	100	35	100 x 85	80/77 x 60	9		128	125	8478BOG100P62	00006907
										

Technical Information

Housing made of Stainless Steel, double ball bearing swivel head (excluding fixed), wheel axle with nut, plate fitting. Wheel made of heat resisting synthetic material, self-lubricating bushing.

Advantages at a glance

Roll performance	● ● ● ● ○
Movement noise	● ● ● ○ ○
Attrition	● ● ● ● ●
Corrosion resistance	● ● ● ● ●

FOOD & CATERING

Plate - Pressed Steel, Elastic Rubber Wheeled Castors

Smooth, Quiet Handling



The Alpha with Elastech has the ability to protect goods that are being transported due to ability to produce a low amount of vibrations. Additionally, it has optimum manoeuvrability and can easily move around obstacles.

 **Load capacity:** 160 - 250 kg

 **Temperature:** - 20 / + 80 °C

 **Overall height:** 128 - 155 mm

 **Wheel diameter:** 100 - 125 mm

	Wheel diameter [mm]	Width of Tread [mm]	Size of Plate [mm]	Plate hole centres [mm]	Plate hole [mm]	Offset [mm]	Overall height [mm]	Load capacity [kg]	Serial number	Order number
Swivel Castors 	100	34	105 x 85	80/77 x 60	9	41	128	160	3470UFR100P62 blue	00001101
	125	40	105 x 85	80/77 x 60	9	40	155	250	3470UFR125P62 blue	00004632
Swivel Castors with total lock 	100	34	105 x 85	80/77 x 60	9	41	128	160	3477UFR100P62 blue	00001426
	125	40	105 x 85	80/77 x 60	9	40	155	250	3477UFR125P62 blue	00007002
Fixed Castors 	100	34	103 x 85	80/77 x 60	9		128	160	3478UFR100P62 blue	00004019
	125	40	103 x 85	80/77 x 60	9		155	250	3478UFR125P62 blue	00004634

Technical Information

Housing made of pressed steel, bright zinc plated, blue passivated, double ball bearing swivel head (excluding fixed version), wheel axle with nut, dust-guard and plate fitting. Wheel centre made of Polyamide and tread consisting of elastic-tyre, non-marking, roller bearing. Other tread options available!

Advantages at a glance

Roll performance	● ● ● ○ ○
Movement noise	● ● ● ● ●
Attrition	● ● ● ○ ○
Corrosion resistance	● ● ● ○ ○

FOOD & CATERING

Plate - Pressed Steel, Elastic Rubber Wheeled Castors

Smooth, Quiet Handling



























The Alpha with Elastech has the ability to protect goods that are being transported due to ability to produce a low amount of vibrations. Additionally, it has optimum manoeuvrability and can easily move around obstacles.

 **Load capacity:** 160 - 400 kg

 **Temperature:** - 20 / + 80 °C

 **Overall height:** 128 - 240 mm

 **Wheel diameter:** 100 - 200 mm

	Wheel diameter [mm]	Width of Tread [mm]	Size of Plate [mm]	Plate hole centres [mm]	Plate hole [mm]	Offset [mm]	Overall height [mm]	Load capacity [kg]	Serial number	Order number
Swivel Castors										
	100	34	105 x 85	80/77 x 60	9	41	128	160	3470UFR100P62	00003464
	125	40	105 x 85	80/77 x 60	9	40	155	250	3470UFR125P62	00001154
	160	46	137 x 105	105 x 80/75	11	55	200	300	3470UFR160P63	00603043
	200	46	137 x 105	105 x 80/75	11	55	240	400	3470UFR200P63	00005606
Swivel Castors with total lock										
	100	34	105 x 85	80/77 x 60	9	41	128	160	3477UFR100P62	00001427
	125	40	105 x 85	80/77 x 60	9	40	155	250	3477UFR125P62	00003805
	160	46	137 x 105	105 x 80/75	11	60	200	300	3477UFR160P63	00030347
	200	46	137 x 105	105 x 80/75	11	55	240	400	3477UFR200P63	00005960
Fixed Castors										
	100	34	103 x 85	80/77 x 60	9		128	160	3478UFR100P62	00000044
	125	40	103 x 85	80/77 x 60	9		155	250	3478UFR125P62	00026592
	160	46	137 x 115	105 x 80/75	11		200	300	3478UFR160P63	00050554
	200	46	137 x 115	105 x 80/75	11		240	400	3478UFR200P63	00000855

Technical Information

Housing made of pressed steel, bright zinc plated, blue passivated, double ball bearing swivel head (excluding fixed version), wheel axle with nut, dust-guard and plate fitting. Wheel centre made of Polyamide and tread consisting of elastic-tyre, non-marking, roller bearing. Other tread options available!

Advantages at a glance





Roll performance	● ● ● ○ ○
Movement noise	● ● ● ● ●
Attrition	● ● ● ○ ○
Corrosion resistance	● ● ● ○ ○



FOOD & CATERING

Plate - Pressed Steel, Polyurethane Wheeled Castors

Industrial Design

The Alpha with Maxtech has a great for functional design and perfect everyday use. It is also extremely hard-wearing and can manoeuvre around easily with its double ball bearing swivel head.

-  **Load capacity:** 150 kg
-  **Temperature:** - 40 / + 80 °C
-  **Overall height:** 108 mm
-  **Wheel diameter:** 80 mm

	Wheel diameter [mm]	Width of Tread [mm]	Size of Plate [mm]	Plate hole centres [mm]	Plate hole [mm]	Offset [mm]	Overall height [mm]	Load capacity [kg]	Serial number	Order number
Swivel Castors	80	38	105 x 85	80/77 x 60	9	40	108	150	3470UAR080P62 grey	00001085
										
Swivel Castors with total lock	80	38	105 x 85	80/77 x 60	9	44,5	108	150	3477UAR080P62 grey	00001390
										
Fixed Castors	80	38	103 x 85	80/77 x 60	9		108	150	3478UAR080P62 grey	00001274
										

Technical Information

Housing made of pressed steel, bright zinc plated, blue passivated, double ball bearing swivel head (excluding fixed version), wheel axle with nut, dust-guard and plate fitting. Wheel centre made of Polyamide and tread consisting of Polyurethane, roller bearing. Other tread options available!

Advantages at a glance

Roll performance	● ● ● ○ ○
Movement noise	● ● ● ○ ○
Attrition	● ● ● ● ○
Corrosion resistance	● ● ● ○ ○

FOOD & CATERING

Plate - Pressed Steel, Polyurethane Wheeled Castors

Industrial Design



























The Alpha with Maxtech has a great for functional design and perfect everyday use. It is also extremely hard-wearing and can manoeuvre around easily with its double ball bearing swivel head.

 **Load capacity:** 150 - 350 kg

 **Temperature:** - 40 / + 80 °C

 **Overall height:** 128 - 240 mm

 **Wheel diameter:** 100 - 200 mm

	Wheel diameter [mm]	Width of Tread [mm]	Size of Plate [mm]	Plate hole centres [mm]	Plate hole [mm]	Offset [mm]	Overall height [mm]	Load capacity [kg]		Serial number	Order number
Swivel Castors											
	100	32	105 x 85	80/77 x 60	9	40	128	150		3470UAR100P62 red	00601009
	125	32	105 x 85	80/77 x 60	9	40	155	200		3470UAR125P62 red	00600597
	160	40	137 x 105	105 x 80/75	11	55	200	350		3470UAR160P63 red	00029633
	200	46	137 x 105	105 x 80/75	11	55	240	350		3470UAR200P63 red	00600946
Swivel Castors with total lock											
	100	32	105 x 85	80/77 x 60	9	41	128	150		3477UAR100P62 red	00600594
	125	32	105 x 85	80/77 x 60	9	40	155	200		3477UAR125P62 red	00600595
	160	40	137 x 105	105 x 80/75	11	60	200	350		3477UAR160P63 red	00030302
	200	46	137 x 105	105 x 80/75	11	55	240	350		3477UAR200P63 red	00600675
Fixed Castors											
	100	32	103 x 85	80/77 x 60	9		128	150		3478UAR100P62 red	00601010
	125	32	105 x 85	80/77 x 60	9		155	200		3478UAR125P62 red	00601001
	160	40	137 x 115	105 x 80/75	11		200	350		3478UAR160P63 red	00029638
	200	46	137 x 115	105 x 80/75	11		240	350		3478UAR200P63 red	00600947

Technical Information

Housing made of pressed steel, bright zinc plated, blue passivated, double ball bearing swivel head (excluding fixed version), wheel axle with nut, dust-guard and plate fitting. Wheel centre made of Polyamide and tread consisting of Polyurethane, roller bearing. Other tread options available!

Advantages at a glance





Roll performance	● ● ● ○ ○
Movement noise	● ● ● ○ ○
Attrition	● ● ● ● ○
Corrosion resistance	● ● ● ○ ○

CLEANING AND MAINTENANCE



Bolt Hole - Stainless Steel, Thermoplastic Wheeled Castors

Increased Productivity & Safety

The Agila with Supratech comes in a variety of fitting options, which allows you to choose the best solution to increase your productivity. Additionally, these castors are easy to wash, chemical resistant and particularly sturdy, especially when transporting goods.

-  **Load capacity:** 40 - 80 kg
-  **Temperature:** - 20 / + 60 °C
-  **Overall height:** 69 - 135 mm
-  **Wheel diameter:** 50 - 100 mm



	Wheel diameter [mm]	Width of Tread [mm]	Centre hole [mm]		Offset [mm]	Overall height [mm]	Load capacity [kg]		Serial number	Order number
Swivel Castors 	50	19	11		24	69	40		7470PJO050P30-11	00036671
	75	25	11		24	100	75		7470PJO075P30-11	00036677
	100	32	11		38	135	80		7470PJO100P30-11	00604071
Swivel Castors with wheel brake 	50	19	11		24	69	40		7475PJO050P30-11	00036674
Swivel Castors with total lock 	75	25	11		24	100	75		7477PJO075P30-11	00036680
	100	32	11		43,5	135	80		7477PJO100P30-11	00603170

Technical Information

Housing made of Stainless Steel, with double ball bearing swivel head, wheel axle with nut, brake pedal made of Polyamide, and bolt hole. The wheel centre is made of Polypropylene and the tread is made of TENTEprene (thermoplastic rubber), grey non-marking with plain bearing. Other tread options available!

Advantages at a glance

Roll performance	● ● ● ○ ○
Movement noise	● ● ● ○ ○
Attrition	● ● ● ○ ○
Corrosion resistance	● ● ● ● ●

CLEANING AND MAINTENANCE

Bolt Hole - Pressed Steel, Nylon Wheeled Castors

Durable Resistance















The Alpha with Duratech is the perfect castor for those wanting less maintenance. It has abrasion-resistance tread and is durable even in cold weather. Additionally it can be easily steered and manoeuvre around bends and other obstacles.

 **Load capacity:** 150 kg

 **Temperature:** - 20 / + 60 °C

 **Overall height:** 108 - 155 mm

 **Wheel diameter:** 80 - 125 mm

	Wheel diameter [mm]	Width of Tread [mm]	Centre hole [mm]		Offset [mm]	Overall height [mm]	Load capacity [kg]		Serial number	Order number
Swivel Castors										
	80	34	13		40	108	150		3470UOO080P30-13	00007216
	100	36	13		40	128	150		3470UOO100P30-13	00005253
	125	40	13		40	155	150		3470UOO125P30-13	00005759
Swivel Castors with total lock										
	80	34	13		44,5	108	150		3477UOO080P30-13	00007217
	100	36	13		41	128	150		3477UOO100P30-13	00005760
	125	40	13		40	155	150		3477UOO125P30-13	00005761

Technical Information

Housing made of pressed steel, bright zinc plated, blue passivated, double ball bearing swivel head, wheel axle with nut and bolt hole. Wheel centre made of Polyamide and plain bearing. Other tread options available!

Advantages at a glance

Roll performance	● ● ● ○ ○
Movement noise	● ● ● ○ ○
Attrition	● ● ● ● ●
Corrosion resistance	● ● ● ○ ○

CLEANING AND MAINTENANCE

Bolt Hole - Pressed Steel, Elastic Rubber Wheeled Castors

Smooth, Quiet Handling

The Alpha with Elastech has the ability to protect goods that are being transported due to ability to produce a low amount of vibrations. Additionally, it has optimum manoeuvrability and can easily move around obstacles.

 **Load capacity:** 160 kg

 **Temperature:** - 20 / + 80 °C

 **Overall height:** 128 - 155 mm

 **Wheel diameter:** 100 - 125 mm

	Wheel diameter [mm]	Width of Tread [mm]	Centre hole [mm]		Offset [mm]	Overall height [mm]	Load capacity [kg]		Serial number	Order number
Swivel Castors	100	34	13		40	128	160		3470UFR100P30-13	00028243
	125	40	13		40	155	160		3470UFR125P30-13	00004858
Swivel Castors with total lock	100	34	13		41	128	160		3477UFR100P30-13	00600563
	125	40	13		40	155	160		3477UFR125P30-13	00004859



Technical Information

Housing made of pressed steel, bright zinc plated, blue passivated, double ball bearing swivel head, wheel axle with nut and bolt hole. Wheel centre made of Polyamide and tread consisting of elastic-tyre, non-marking, roller bearing. Other tread options available!

Advantages at a glance

Roll performance	● ● ● ○ ○
Movement noise	● ● ● ● ●
Attrition	● ● ● ○ ○
Corrosion resistance	● ● ● ○ ○

CLEANING AND MAINTENANCE

Plate - Stainless Steel, Nylon Wheeled Castors

Stainless Steel Resistance

The Alpha with Duratech is ideal for those needing a stainless steel option. The stainless steel housing allows for a very high resistance to a variety of items, such as water and humidity as well as various acids, fats and strong cleaning agents.



























 **Load capacity:** 200 - 500 kg

 **Temperature:** - 40 / + 80 °C

 **Overall height:** 108 - 240 mm

 **Wheel diameter:** 80 - 200 mm



	Wheel diameter [mm]	Width of Tread [mm]	Size of Plate [mm]	Plate hole centres [mm]	Plate hole [mm]	Offset [mm]	Overall height [mm]	Load capacity [kg]	Serial number	Order number
Swivel Castors										
	80	34	105 x 85	80/77 x 60	9	44,5	108	200	8470UOO080P62	00005866
	100	36	105 x 85	80/77 x 60	9	41	128	200	8470UOO100P62	00600147
	125	40	105 x 85	80/77 x 60	9	40	155	250	8470UOO125P62	00600907
	160	40	137 x 105	105 x 80/75	11	55	200	500	8470UOO160P63	00601034
	200	50	137 x 105	105 x 80/75	11	55	240	500	8470UOO200P63	00600494
Swivel Castors with total lock										
	80	34	105 x 85	80/77 x 60	9	44,5	108	200	8477UOO080P62	00006007
	100	36	105 x 85	80/77 x 60	9	41	128	200	8477UOO100P62	00601032
	125	40	105 x 85	80/77 x 60	9	40	155	200	8477UOO125P62	00026018
	160	40	137 x 105	105 x 80/75	11	60	200	500	8477UOO160P63	00025938
	200	50	137 x 105	105 x 80/75	11	55	240	500	8477UOO200P63	00026019
Fixed Castors										
	80	34	100 x 85	80/77 x 60	9		108	200	8478UOO080P62	00600944
	100	36	100 x 85	80/77 x 60	9		128	200	8478UOO100P62	00601226
	125	40	100 x 85	80/77 x 60	9		155	250	8478UOO125P62	00600495
	160	40	137 x 115	105 x 80/75	11		200	500	8478UOO160P63	00022560
	200	50	137 x 115	105 x 80/75	11		240	500	8478UOO200P63	00026021

Technical Information

Housing made of Stainless Steel, double ball bearing swivel head (excluding fixed version), wheel axle with nut, plate fitting. Wheel centre made of Polyamide, plain bearing

Advantages at a glance

Roll performance	● ● ● ○ ○
Movement noise	● ● ● ○ ○
Attrition	● ● ● ● ●
Corrosion resistance	● ● ● ● ●

CLEANING AND MAINTENANCE

Plate - Pressed Steel, Nylon Wheeled Castors

Durable Resistance



























The Alpha with Duratech is the perfect castor for those wanting less maintenance. It has abrasion-resistance tread and is durable even in cold weather. Additionally it can be easily steered and manoeuvre around bends and other obstacles.

 **Load capacity:** 200 - 350 kg

 **Temperature:** - 40 / + 80 °C

 **Overall height:** 108 - 240 mm

 **Wheel diameter:** 80 - 200 mm

	Wheel diameter [mm]	Width of Tread [mm]	Size of Plate [mm]	Plate hole centres [mm]	Plate hole [mm]	Offset [mm]	Overall height [mm]	Load capacity [kg]		Serial number	Order number
Swivel Castors											
	80	34	105 x 85	80/77 x 60	9	40	108	200		3470UOO080P62	00601054
	100	36	105 x 85	80/77 x 60	9	41	128	200		3470UOR100P62	00002710
	125	40	105 x 85	80/77 x 60	9	40	155	250		3470UOR125P62	00005185
	160	40	137 x 105	105 x 80/75	11	55	200	350		3470UOR160P63	00029874
	200	50	137 x 105	105 x 80/75	11	55	240	350		3470UOR200P63	00029868
Swivel Castors with total lock											
	80	34	105 x 85	80/77 x 60	9	44,5	108	200		3477UOO080P62	00005658
	100	36	105 x 85	80/77 x 60	9	41	128	200		3477UOR100P62	00006879
	125	40	105 x 85	80/77 x 60	9	40	155	250		3477UOR125P62	00003431
	160	40	137 x 105	105 x 80/75	11	60	200	350		3477UOR160P63	00029866
	200	50	137 x 105	105 x 80/75	11	55	240	350		3477UOR200P63	00029853
Fixed Castors											
	80	34	103 x 85	80/77 x 60	9		108	200		3478UOO080P62	00005659
	100	36	103 x 85	80/77 x 60	9		128	200		3478UOR100P62	00002711
	125	40	103 x 85	80/77 x 60	9		155	250		3478UOR125P62	00003430
	160	40	137 x 115	105 x 80/75	11		200	350		3478UOR160P63	00004875
	200	50	137 x 115	105 x 80/75	11		240	350		3478UOR200P63	00003029

Technical Information

Housing made of pressed steel, bright zinc plated, blue passivated, double ball bearing swivel head (excluding fixed version), wheel axle with nut, dust-guard and plate fitting. Wheel centre made of Polyamide and plain bearing (UOO) or roller bearing (UOR). Other tread options available!

Advantages at a glance





Roll performance	● ● ● ○ ○
Movement noise	● ● ● ○ ○
Attrition	● ● ● ● ●
Corrosion resistance	● ● ● ○ ○



CLEANING AND MAINTENANCE

Plate - Pressed Steel, Heat Resistant Synthetic Wheeled Castors

Durable, Heat Resistance

The Alpha with Duratech heat is the perfect solution for those working in temperatures that range from -40° to +280°. Additionally, it has optimum manoeuvrability and can easily move around obstacles.

-  **Load capacity:** 125 - 150 kg
-  **Temperature:** - 40 / + 280 °C
-  **Overall height:** 128 mm
-  **Wheel diameter:** 100 mm

	Wheel diameter [mm]	Width of Tread [mm]	Size of Plate [mm]	Plate hole centres [mm]	Plate hole [mm]	Offset [mm]	Overall height [mm]	Load capacity [kg]	Serial number	Order number
Swivel Castors	100	35	105 x 85	80/77 x 60	9	41	128	125	3470BOG100P62 TUK	00602549
										
Fixed Castors	100	35	103 x 85	80/77 x 60	9		128	150	3478BOG100P62 TUK	00602517
										

Technical Information

Housing made of pressed steel, bright zinc plated, blue passivated, double ball bearing swivel head (excluding fixed), wheel axle with nut, dustguard, plate fitting. Wheel made of heat resisting synthetic material, self-lubricating bushing.

Advantages at a glance

Roll performance	● ● ● ● ○
Movement noise	● ● ● ○ ○
Attrition	● ● ● ● ●
Corrosion resistance	● ● ● ● ●

CLEANING AND MAINTENANCE

Plate - Stainless Steel, Heat Resistant Synthetic Wheeled Castors

Durable, Heat Resistance

The Alpha with Duratech heat is the perfect solution for those working in temperatures that range from -40° to +280°. Additionally, the stainless steel version can accommodate for strict hygiene regulations and it also highly resistance to many environmental factors including water, grease, fats and cleaning agents.

















 **Load capacity:** 125 kg

 **Temperature:** - 40 / + 280 °C

 **Overall height:** 128 mm

 **Wheel diameter:** 100 mm



	Wheel diameter [mm]	Width of Tread [mm]	Size of Plate [mm]	Plate hole centres [mm]	Plate hole [mm]	Offset [mm]	Overall height [mm]	Load capacity [kg]	Serial number	Order number
Swivel Castors	 100	 35	 105 x 85	 80/77 x 60	 9	 41	 128	 125	8470BOG100P62	00601576
										
Fixed Castors	 100	 35	 100 x 85	 80/77 x 60	 9		 128	 125	8478BOG100P62	00006907
										

Technical Information

Housing made of Stainless Steel, double ball bearing swivel head (excluding fixed), wheel axle with nut, plate fitting. Wheel made of heat resisting synthetic material, self-lubricating bushing.

Advantages at a glance

Roll performance	● ● ● ● ○
Movement noise	● ● ● ○ ○
Attrition	● ● ● ● ●
Corrosion resistance	● ● ● ● ●

CLEANING AND MAINTENANCE

Plate - Pressed Steel, Elastic Rubber Wheeled Castors

Smooth, Quiet Handling

























The Alpha with Elastech has the ability to protect goods that are being transported due to ability to produce a low amount of vibrations. Additionally, it has optimum manoeuvrability and can easily move around obstacles.

 **Load capacity:** 160 - 250 kg

 **Temperature:** - 20 / + 80 °C

 **Overall height:** 128 - 155 mm

 **Wheel diameter:** 100 - 125 mm

	Wheel diameter [mm]	Width of Tread [mm]	Size of Plate [mm]	Plate hole centres [mm]	Plate hole [mm]	Offset [mm]	Overall height [mm]	Load capacity [kg]	Serial number	Order number
Swivel Castors										
	100	34	105 x 85	80/77 x 60	9	41	128	160	3470UFR100P62 blue	00001101
	125	40	105 x 85	80/77 x 60	9	40	155	250	3470UFR125P62 blue	00004632
Swivel Castors with total lock										
	100	34	105 x 85	80/77 x 60	9	41	128	160	3477UFR100P62 blue	00001426
	125	40	105 x 85	80/77 x 60	9	40	155	250	3477UFR125P62 blue	00007002
Fixed Castors										
	100	34	103 x 85	80/77 x 60	9		128	160	3478UFR100P62 blue	00004019
	125	40	103 x 85	80/77 x 60	9		155	250	3478UFR125P62 blue	00004634

Technical Information

Housing made of pressed steel, bright zinc plated, blue passivated, double ball bearing swivel head (excluding fixed version), wheel axle with nut, dust-guard and plate fitting. Wheel centre made of Polyamide and tread consisting of elastic-tyre, non-marking, roller bearing. Other tread options available!

Advantages at a glance

Roll performance	● ● ● ○ ○
Movement noise	● ● ● ● ●
Attrition	● ● ● ○ ○
Corrosion resistance	● ● ● ○ ○

CLEANING AND MAINTENANCE

Plate - Pressed Steel, Elastic Rubber Wheeled Castors

Smooth, Quiet Handling



























The Alpha with Elastech has the ability to protect goods that are being transported due to ability to produce a low amount of vibrations. Additionally, it has optimum manoeuvrability and can easily move around obstacles.

 **Load capacity:** 160 - 400 kg

 **Temperature:** - 20 / + 80 °C

 **Overall height:** 128 - 240 mm

 **Wheel diameter:** 100 - 200 mm

	Wheel diameter [mm]	Width of Tread [mm]	Size of Plate [mm]	Plate hole centres [mm]	Plate hole [mm]	Offset [mm]	Overall height [mm]	Load capacity [kg]		Serial number	Order number
Swivel Castors											
	100	34	105 x 85	80/77 x 60	9	41	128	160		3470UFR100P62	00003464
	125	40	105 x 85	80/77 x 60	9	40	155	250		3470UFR125P62	00001154
	160	46	137 x 105	105 x 80/75	11	55	200	300		3470UFR160P63	00603043
	200	46	137 x 105	105 x 80/75	11	55	240	400		3470UFR200P63	00005606
Swivel Castors with total lock											
	100	34	105 x 85	80/77 x 60	9	41	128	160		3477UFR100P62	00001427
	125	40	105 x 85	80/77 x 60	9	40	155	250		3477UFR125P62	00003805
	160	46	137 x 105	105 x 80/75	11	60	200	300		3477UFR160P63	00030347
	200	46	137 x 105	105 x 80/75	11	55	240	400		3477UFR200P63	00005960
Fixed Castors											
	100	34	103 x 85	80/77 x 60	9		128	160		3478UFR100P62	00000044
	125	40	103 x 85	80/77 x 60	9		155	250		3478UFR125P62	00026592
	160	46	137 x 115	105 x 80/75	11		200	300		3478UFR160P63	00050554
	200	46	137 x 115	105 x 80/75	11		240	400		3478UFR200P63	00000855

Technical Information

Housing made of pressed steel, bright zinc plated, blue passivated, double ball bearing swivel head (excluding fixed version), wheel axle with nut, dust-guard and plate fitting. Wheel centre made of Polyamide and tread consisting of elastic-tyre, non-marking, roller bearing. Other tread options available!

Advantages at a glance





Roll performance	● ● ● ○ ○
Movement noise	● ● ● ● ●
Attrition	● ● ● ○ ○
Corrosion resistance	● ● ● ○ ○



CLEANING AND MAINTENANCE

Plate - Pressed Steel, Polyurethane Wheeled Castors

Industrial Design

The Alpha with Maxtech has a great for functional design and perfect everyday use. It is also extremely hard-wearing and can manoeuvre around easily with its double ball bearing swivel head.

-  **Load capacity:** 150 kg
-  **Temperature:** - 40 / + 80 °C
-  **Overall height:** 108 mm
-  **Wheel diameter:** 80 mm

	Wheel diameter [mm]	Width of Tread [mm]	Size of Plate [mm]	Plate hole centres [mm]	Plate hole [mm]	Offset [mm]	Overall height [mm]	Load capacity [kg]	Serial number	Order number
Swivel Castors	80	38	105 x 85	80/77 x 60	9	40	108	150	3470UAR080P62 grey	00001085
										
Swivel Castors with total lock	80	38	105 x 85	80/77 x 60	9	44,5	108	150	3477UAR080P62 grey	00001390
										
Fixed Castors	80	38	103 x 85	80/77 x 60	9		108	150	3478UAR080P62 grey	00001274
										

Technical Information

Housing made of pressed steel, bright zinc plated, blue passivated, double ball bearing swivel head (excluding fixed version), wheel axle with nut, dust-guard and plate fitting. Wheel centre made of Polyamide and tread consisting of Polyurethane, roller bearing. Other tread options available!

Advantages at a glance

Roll performance	● ● ● ○ ○
Movement noise	● ● ● ○ ○
Attrition	● ● ● ● ○
Corrosion resistance	● ● ● ○ ○

CLEANING AND MAINTENANCE

Plate - Pressed Steel, Polyurethane Wheeled Castors

Industrial Design



























The Alpha with Maxtech has a great for functional design and perfect everyday use. It is also extremely hard-wearing and can manoeuvre around easily with its double ball bearing swivel head.

 **Load capacity:** 150 - 350 kg

 **Temperature:** - 40 / + 80 °C

 **Overall height:** 128 - 240 mm

 **Wheel diameter:** 100 - 200 mm

	Wheel diameter [mm]	Width of Tread [mm]	Size of Plate [mm]	Plate hole centres [mm]	Plate hole [mm]	Offset [mm]	Overall height [mm]	Load capacity [kg]		Serial number	Order number
Swivel Castors											
	100	32	105 x 85	80/77 x 60	9	40	128	150		3470UAR100P62 red	00601009
	125	32	105 x 85	80/77 x 60	9	40	155	200		3470UAR125P62 red	00600597
	160	40	137 x 105	105 x 80/75	11	55	200	350		3470UAR160P63 red	00029633
	200	46	137 x 105	105 x 80/75	11	55	240	350		3470UAR200P63 red	00600946
Swivel Castors with total lock											
	100	32	105 x 85	80/77 x 60	9	41	128	150		3477UAR100P62 red	00600594
	125	32	105 x 85	80/77 x 60	9	40	155	200		3477UAR125P62 red	00600595
	160	40	137 x 105	105 x 80/75	11	60	200	350		3477UAR160P63 red	00030302
	200	46	137 x 105	105 x 80/75	11	55	240	350		3477UAR200P63 red	00600675
Fixed Castors											
	100	32	103 x 85	80/77 x 60	9		128	150		3478UAR100P62 red	00601010
	125	32	105 x 85	80/77 x 60	9		155	200		3478UAR125P62 red	00601001
	160	40	137 x 115	105 x 80/75	11		200	350		3478UAR160P63 red	00029638
	200	46	137 x 115	105 x 80/75	11		240	350		3478UAR200P63 red	00600947

Technical Information

Housing made of pressed steel, bright zinc plated, blue passivated, double ball bearing swivel head (excluding fixed version), wheel axle with nut, dust-guard and plate fitting. Wheel centre made of Polyamide and tread consisting of Polyurethane, roller bearing. Other tread options available!

Advantages at a glance





Roll performance	● ● ● ○ ○
Movement noise	● ● ● ○ ○
Attrition	● ● ● ● ○
Corrosion resistance	● ● ● ○ ○

INTRALOGISTICS

Bolt Hole - Pressed Steel, Polyurethane Wheeled Castors

Compact Durability

The Agila with Novatech may be small, but it is highly durable and less maintenance. Additionally it is non-marking and suitable for sensitive floors.

-  **Load capacity:** 100 kg
-  **Temperature:** - 20 / + 60 °C
-  **Overall height:** 58 mm
-  **Wheel diameter:** 35 mm

	Wheel diameter [mm]	Width of Tread [mm]	Threaded stem [mm]		Offset [mm]	Overall height [mm]	Load capacity [kg]		Serial number	Order number
Swivel Castors	35	25	10 x 20		13,5	58	100		2470ETP035S50-M10x20	00028493



Technical Information

Swivel castor, housing made of pressed steel, bright zinc plated, blue passivated, double ball bearing swivel head, socket head cap screw, loose fitted. Wheel centre made of steel and tread consisting of Polyurethane, casted, precision ball bearing. Other tread options available!

Advantages at a glance

Roll performance	● ● ● ● ○
Movement noise	● ● ● ○ ○
Attrition	● ● ● ○ ○
Corrosion resistance	● ● ● ○ ○

INTRALOGISTICS

Bolt Hole - Pressed Steel, Elastic Rubber Wheeled Castor

Smooth, Quiet Handling

The Alpha with Elastech has the ability to protect goods that are being transported due to ability to produce a low amount of vibrations. Additionally, it has optimum manoeuvrability and can easily move around obstacles.

 **Load capacity:** 160 kg

 **Temperature:** - 20 / + 80 °C

 **Overall height:** 128 - 155 mm

 **Wheel diameter:** 100 - 125 mm

	Wheel diameter [mm]	Width of Tread [mm]	Centre hole [mm]		Offset [mm]	Overall height [mm]	Load capacity [kg]		Serial number	Order number
Swivel Castors	100	34	13		40	128	160		3470UFR100P30-13	00028243
	125	40	13		40	155	160		3470UFR125P30-13	00004858
Swivel Castors with total lock	100	34	13		41	128	160		3477UFR100P30-13	00600563
	125	40	13		40	155	160		3477UFR125P30-13	00004859



Technical Information

Housing made of pressed steel, bright zinc plated, blue passivated, double ball bearing swivel head, wheel axle with nut and bolt hole. Wheel centre made of Polyamide and tread consisting of elastic-tyre, non-marking, roller bearing. Other tread options available!

Advantages at a glance

Roll performance	● ● ● ○ ○
Movement noise	● ● ● ● ●
Attrition	● ● ● ○ ○
Corrosion resistance	● ● ● ○ ○

INTRALOGISTICS

Bolt Hole - Pressed Steel, Nylon Wheeled Castors

Durable Resistance















The Alpha with Duratech is the perfect castor for those wanting less maintenance. It has abrasion-resistance tread and is durable even in cold weather. Additionally it can be easily steered and manoeuvre around bends and other obstacles.

 **Load capacity:** 150 kg

 **Temperature:** - 20 / + 60 °C

 **Overall height:** 108 - 155 mm

 **Wheel diameter:** 80 - 125 mm

	Wheel diameter [mm]	Width of Tread [mm]	Centre hole [mm]		Offset [mm]	Overall height [mm]	Load capacity [kg]		Serial number	Order number
Swivel Castors										
	80	34	13		40	108	150		3470UOO080P30-13	00007216
	100	36	13		40	128	150		3470UOO100P30-13	00005253
	125	40	13		40	155	150		3470UOO125P30-13	00005759
Swivel Castors with total lock										
	80	34	13		44,5	108	150		3477UOO080P30-13	00007217
	100	36	13		41	128	150		3477UOO100P30-13	00005760
	125	40	13		40	155	150		3477UOO125P30-13	00005761

Technical Information

Housing made of pressed steel, bright zinc plated, blue passivated, double ball bearing swivel head, wheel axle with nut and bolt hole. Wheel centre made of Polyamide and plain bearing. Other tread options available!

Advantages at a glance

Roll performance	● ● ● ○ ○
Movement noise	● ● ● ○ ○
Attrition	● ● ● ● ●
Corrosion resistance	● ● ● ○ ○

INTRALOGISTICS

Plate - Pressed Steel, Solid Rubber Wheeled Castors

Robust Manoeuvrability





































The Alpha with Puratech has robust standard and ideal manoeuvrability due to its double ball bearing swivel head. Additionally, it is able to make non-marking movements, which is ideal for sensitive floors.

 **Load capacity:** 70 - 205 kg

 **Temperature:** - 20 / + 60 °C

 **Overall height:** 128 - 240 mm

 **Wheel diameter:** 100 - 200 mm

	Wheel diameter [mm]	Width of Tread [mm]	Size of Plate [mm]	Plate hole centres [mm]	Plate hole [mm]	Offset [mm]	Overall height [mm]	Load capacity [kg]	Serial number	Order number
Swivel Castors										
	100	20	105 x 85	80/77 x 60	9	41	128	70	3370DVR100P62	00031136
	125	24	105 x 85	80/77 x 60	9	40	155	100	3370DVR125P62	00031137
	160	23	137 x 105	105 x 80/77	11	57,5	200	135	3370DVR160P63	00603614
	200	30	137 x 105	105 x 80/77	11	52,5	240	205	3370DVR200P63	00600780
	200	50	137 x 105	105 x 80/75	11	55	240	205	3470DVR200P63	00005927
Swivel Castors with total lock										
	100	20	105 x 85	80/77 x 60	9	41	128	70	3377DVR100P62	00031141
	125	24	105 x 85	80/77 x 60	9	40	155	100	3377DVR125P62	00031142
	160	23	137 x 105	105 x 80/77	11	57,5	200	135	3377DVR160P63	00031143
	200	30	137 x 105	105 x 80/77	11	52,5	240	205	3377DVR200P63	00600890
Fixed Castors										
	100	30	103 x 85	80/77 x 60	9		128	70	3478DVR100P62	00031987
	125	24	103 x 85	80/77 x 60	9		155	100	3478DVR125P62	00006230
	160	40	137 x 115	105 x 80/75	11		200	135	3478DVR160P63	00000787
	200	50	137 x 115	105 x 80/75	11		240	205	3478DVR200P63	00022458
Swivel Castors with total lock										
	200	50	137 x 105	105 x 80/75	11	55	240	205	3472DVP200P63	

Directional lock 3471

Additional Options:



00002600

Technical Information

Housing made of pressed steel, bright zinc plated, blue passivated, double ball bearing swivel head (excluding fixed version), wheel axle with nut and plate fitting. Wheel centre made of pressed steel and tread consisting of solid rubber, black, roller bearing. Other tread options available!

Advantages at a glance

Roll performance	● ● ● ○ ○
Movement noise	● ● ● ○ ○
Attrition	● ● ● ○ ○
Corrosion resistance	● ● ● ○ ○

INTRALOGISTICS

Plate - Pressed Steel, Solid Rubber Wheeled Castors

Ergonomically Friendly Use



The Alpha with Puratech is the ideal solutions for those looking to optimise their roll resistance and to lighten the load for users. Additionally, the wheel tread also protects sensitive floors by preventing wheel markings.

 **Load capacity:** 135 - 205 kg

 **Temperature:** - 20 / + 60 °C

 **Overall height:** 200 - 240 mm

 **Wheel diameter:** 160 - 200 mm

	Wheel diameter [mm]	Width of Tread [mm]	Size of Plate [mm]	Plate hole centres [mm]	Plate hole [mm]	Offset [mm]	Overall height [mm]	Load capacity [kg]		Serial number	Order number
Swivel Castors 	160	40	137 x 105	105 x 80/75	11	55	200	135		3470PIR160P63	00023215
	200	50	137 x 105	105 x 80/75	11	55	240	205		3470PIR200P63	00053839
Swivel Castors with total lock 	160	40	137 x 105	105 x 80/75	11	60	200	135		3477PIR160P63	00053178
	200	50	137 x 105	105 x 80/75	11	55	240	205		3477PIR200P63	00600143
Fixed Castors 	160	40	137 x 115	105 x 80/75	11		200	135		3478PIR160P63	00600714
	200	50	137 x 115	105 x 80/75	11		240	205		3478PIR200P63	00053651

Technical Information

Housing made of pressed steel, bright zinc plated, blue passivated, double ball bearing swivel head (excluding fixed version), wheel axle with nut, dust-guard and plate fitting. Wheel centre made of Polypropylene and tread consisting of solid rubber, grey non-marking, roller bearing. Other tread options available!

Advantages at a glance

Roll performance	● ● ● ○ ○
Movement noise	● ● ● ○ ○
Attrition	● ● ● ○ ○
Corrosion resistance	● ● ● ○ ○

INTRALOGISTICS

Plate - Pressed Steel, Elastic Rubber Wheeled Castors

Smooth, Quiet Handling

























The Alpha with Elastech has the ability to protect goods that are being transported due to ability to produce a low amount of vibrations. Additionally, it has optimum manoeuvrability and can easily move around obstacles.

 **Load capacity:** 160 - 250 kg

 **Temperature:** - 20 / + 80 °C

 **Overall height:** 128 - 155 mm

 **Wheel diameter:** 100 - 125 mm

	Wheel diameter [mm]	Width of Tread [mm]	Size of Plate [mm]	Plate hole centres [mm]	Plate hole [mm]	Offset [mm]	Overall height [mm]	Load capacity [kg]	Serial number	Order number
Swivel Castors										
	100	34	105 x 85	80/77 x 60	9	41	128	160	3470UFR100P62 blue	00001101
	125	40	105 x 85	80/77 x 60	9	40	155	250	3470UFR125P62 blue	00004632
Swivel Castors with total lock										
	100	34	105 x 85	80/77 x 60	9	41	128	160	3477UFR100P62 blue	00001426
	125	40	105 x 85	80/77 x 60	9	40	155	250	3477UFR125P62 blue	00007002
Fixed Castors										
	100	34	103 x 85	80/77 x 60	9		128	160	3478UFR100P62 blue	00004019
	125	40	103 x 85	80/77 x 60	9		155	250	3478UFR125P62 blue	00004634

Technical Information

Housing made of pressed steel, bright zinc plated, blue passivated, double ball bearing swivel head (excluding fixed version), wheel axle with nut, dust-guard and plate fitting. Wheel centre made of Polyamide and tread consisting of elastic-tyre, non-marking, roller bearing. Other tread options available!

Advantages at a glance

Roll performance	● ● ● ○ ○
Movement noise	● ● ● ● ●
Attrition	● ● ● ○ ○
Corrosion resistance	● ● ● ○ ○

INTRALOGISTICS

Plate - Pressed Steel, Elastic Rubber Wheeled Castors

Smooth, Quiet Handling



























The Alpha with Elastech has the ability to protect goods that are being transported due to ability to produce a low amount of vibrations. Additionally, it has optimum manoeuvrability and can easily move around obstacles.

 **Load capacity:** 160 - 400 kg

 **Temperature:** - 20 / + 80 °C

 **Overall height:** 128 - 240 mm

 **Wheel diameter:** 100 - 200 mm

	Wheel diameter [mm]	Width of Tread [mm]	Size of Plate [mm]	Plate hole centres [mm]	Plate hole [mm]	Offset [mm]	Overall height [mm]	Load capacity [kg]		Serial number	Order number
Swivel Castors											
	100	34	105 x 85	80/77 x 60	9	41	128	160		3470UFR100P62	00003464
	125	40	105 x 85	80/77 x 60	9	40	155	250		3470UFR125P62	00001154
	160	46	137 x 105	105 x 80/75	11	55	200	300		3470UFR160P63	00603043
	200	46	137 x 105	105 x 80/75	11	55	240	400		3470UFR200P63	00005606
Swivel Castors with total lock											
	100	34	105 x 85	80/77 x 60	9	41	128	160		3477UFR100P62	00001427
	125	40	105 x 85	80/77 x 60	9	40	155	250		3477UFR125P62	00003805
	160	46	137 x 105	105 x 80/75	11	60	200	300		3477UFR160P63	00030347
	200	46	137 x 105	105 x 80/75	11	55	240	400		3477UFR200P63	00005960
Fixed Castors											
	100	34	103 x 85	80/77 x 60	9		128	160		3478UFR100P62	00000044
	125	40	103 x 85	80/77 x 60	9		155	250		3478UFR125P62	00026592
	160	46	137 x 115	105 x 80/75	11		200	300		3478UFR160P63	00050554
	200	46	137 x 115	105 x 80/75	11		240	400		3478UFR200P63	00000855

Technical Information

Housing made of pressed steel, bright zinc plated, blue passivated, double ball bearing swivel head (excluding fixed version), wheel axle with nut, dust-guard and plate fitting. Wheel centre made of Polyamide and tread consisting of elastic-tyre, non-marking, roller bearing. Other tread options available!

Advantages at a glance

Roll performance	● ● ● ○ ○
Movement noise	● ● ● ● ●
Attrition	● ● ● ○ ○
Corrosion resistance	● ● ● ○ ○

INTRALOGISTICS

Plate - Pressed Steel, Nylon Wheeled Castors

Durable Resistance



























The Alpha with Duratech is the perfect castor for those wanting less maintenance. It has abrasion-resistance tread and is durable even in cold weather. Additionally it can be easily steered and manoeuvre around bends and other obstacles.

 **Load capacity:** 200 - 350 kg

 **Temperature:** - 40 / + 80 °C

 **Overall height:** 108 - 240 mm

 **Wheel diameter:** 80 - 200 mm

	Wheel diameter [mm]	Width of Tread [mm]	Size of Plate [mm]	Plate hole centres [mm]	Plate hole [mm]	Offset [mm]	Overall height [mm]	Load capacity [kg]		Serial number	Order number
Swivel Castors											
	80	34	105 x 85	80/77 x 60	9	40	108	200		3470UOO080P62	00601054
	100	36	105 x 85	80/77 x 60	9	41	128	200		3470UOR100P62	00002710
	125	40	105 x 85	80/77 x 60	9	40	155	250		3470UOR125P62	00005185
	160	40	137 x 105	105 x 80/75	11	55	200	350		3470UOR160P63	00029874
	200	50	137 x 105	105 x 80/75	11	55	240	350		3470UOR200P63	00029868
Swivel Castors with total lock											
	80	34	105 x 85	80/77 x 60	9	44,5	108	200		3477UOO080P62	00005658
	100	36	105 x 85	80/77 x 60	9	41	128	200		3477UOR100P62	00006879
	125	40	105 x 85	80/77 x 60	9	40	155	250		3477UOR125P62	00003431
	160	40	137 x 105	105 x 80/75	11	60	200	350		3477UOR160P63	00029866
	200	50	137 x 105	105 x 80/75	11	55	240	350		3477UOR200P63	00029853
Fixed Castors											
	80	34	103 x 85	80/77 x 60	9		108	200		3478UOO080P62	00005659
	100	36	103 x 85	80/77 x 60	9		128	200		3478UOR100P62	00002711
	125	40	103 x 85	80/77 x 60	9		155	250		3478UOR125P62	00003430
	160	40	137 x 115	105 x 80/75	11		200	350		3478UOR160P63	00004875
	200	50	137 x 115	105 x 80/75	11		240	350		3478UOR200P63	00003029

Technical Information

Housing made of pressed steel, bright zinc plated, blue passivated, double ball bearing swivel head (excluding fixed version), wheel axle with nut, dust-guard and plate fitting. Wheel centre made of Polyamide and plain bearing (UOO) or roller bearing (UOR). Other tread options available!

Advantages at a glance

Roll performance	● ● ● ○ ○
Movement noise	● ● ● ○ ○
Attrition	● ● ● ● ●
Corrosion resistance	● ● ● ○ ○

INTRALOGISTICS

Plate - Pressed Steel, Polyurethane Wheeled Castors

Industrial Design

The Alpha with Maxtech has a great for functional design and perfect everyday use. It is also extremely hard-wearing and can manoeuvre around easily with its double ball bearing swivel head.

 **Load capacity:** 350 kg

 **Temperature:** - 40 / + 80 °C

 **Overall height:** 200 - 240 mm

 **Wheel diameter:** 160 - 200 mm

	Wheel diameter [mm]	Width of Tread [mm]	Size of Plate [mm]	Plate hole centres [mm]	Plate hole [mm]	Offset [mm]	Overall height [mm]	Load capacity [kg]	Serial number	Order number
Swivel Castors	160	40	137 x 105	105 x 80/75	11	55	200	350	3470UAR160P63 red	00029633
	200	46	137 x 105	105 x 80/75	11	55	240	350	3470UAR200P63 red	00600946
Swivel Castors with total lock	160	40	137 x 105	105 x 80/75	11	60	200	350	3477UAR160P63 red	00030302
	200	46	137 x 105	105 x 80/75	11	55	240	350	3477UAR200P63 red	00600675
Fixed Castors	160	40	137 x 115	105 x 80/75	11		200	350	3478UAR160P63 red	00029638
	200	46	137 x 115	105 x 80/75	11		240	350	3478UAR200P63 red	00600947

Technical Information

Housing made of pressed steel, bright zinc plated, blue passivated, double ball bearing swivel head (excluding fixed version), wheel axle with nut, dust-guard and plate fitting. Wheel centre made of Polyamide and tread consisting of Polyurethane, roller bearing. Other tread options available!

Advantages at a glance

Roll performance	● ● ● ○ ○
Movement noise	● ● ● ○ ○
Attrition	● ● ● ● ○
Corrosion resistance	● ● ● ○ ○

INTRALOGISTICS

Plate - Pressed Steel, Vulcanized Elastic Wheeled Castors

Easy Handling & Less Noise



The Delta with Elastech has some of the smoothest handling properties and can easily navigate around obstacles. Additionally this castor prevents vibrations and reduces noise emission.

 **Load capacity:** 300 - 450 kg

 **Temperature:** - 20 / + 85 °C

 **Overall height:** 178 - 250 mm

 **Wheel diameter:** 125 - 200 mm

	Wheel diameter [mm]	Width of Tread [mm]	Size of Plate [mm]	Plate hole centres [mm]	Plate hole [mm]	Offset [mm]	Overall height [mm]	Load capacity [kg]		Serial number	Order number
Swivel Castors 	125	50	137 x 105	105 x 80/75	11	55	178	300 240		3640IEP125P63	00033538
	160	50	137 x 105	105 x 80/75	11	55	210	350 280		3640IEP160P63	00033540
	200	50	137 x 105	105 x 80/75	11	55	250	450 360		3640IEP200P63	00033546
Swivel Castors with total lock 	125	50	137 x 105	105 x 80/75	11	55	178	300 240		3642IEP125P63	00602846
	160	50	137 x 105	105 x 80/75	11	55	210	350 280		3642IEP160P63	00833692
	200	50	137 x 105	105 x 80/75	11	55	250	450 360		3642IEP200P63	00033705
Fixed Castors 	125	50	137 x 115	105 x 80/75	11		178	300 240		3648IEP125P63	00033574
	160	50	137 x 115	105 x 80/75	11		210	350 280		3648IEP160P63	00833575
	200	50	137 x 115	105 x 80/75	11		250	450 360		3648IEP200P63	00033576

Technical Information

Housing made of heavy pressed steel, bright zinc plated, blue passivated, precision ball bearing swivel head (excluding fixed version), sealed, wheel axle with nut and plate fitting. Wheel centre made of Aluminium and tread consisting of black elastic-tyre, vulcanised, precision ball bearing. Other tread options available!

Advantages at a glance





Roll performance	● ● ● ○ ○
Movement noise	● ● ● ○ ○
Attrition	● ● ● ○ ○
Corrosion resistance	● ● ● ○ ○



INTRALOGISTICS

Plate - Steel Welded, Polyurethane Casted Castors

Solid Stability

The Kappa with Novatech has guaranteed stability due to its two hardened double ball raceways. Additionally, it has a welded solid steel housing for high load capacities and an abrasion-resistant tread that is highly durable and requires less maintenance.

-  **Load capacity:** 550 - 1000 kg
-  **Temperature:** - 20 / + 60 °C
-  **Overall height:** 170 - 245 mm
-  **Wheel diameter:** 125 - 200 mm

	Wheel diameter [mm]	Width of Tread [mm]	Size of Plate [mm]	Plate hole centres [mm]	Plate hole [mm]	Offset [mm]	Overall height [mm]	Load capacity [kg]	Serial number	Order number
Swivel Castors 	125	50	135 x 110	105 x 80/75	11	48	170	660 550	9680FTP125P63	00001452
	160	50	135 x 110	105 x 80/75	11	58	205	900 750	9680FTP160P63	00001569
	200	50	135 x 110	105 x 80/75	11	59	245	1200 1000	9680FTP200P63	00001001
Swivel Castors with total lock 	125	50	135 x 110	105 x 80/75	11	48	170	660 550	9682FTP125P63	00002029
	160	50	135 x 110	105 x 80/75	11	58	205	900 750	9682FTP160P63	00004607
	200	50	135 x 110	105 x 80/75	11	59	245	1200 1000	9682FTP200P63	00001690
Fixed Castors 	125	50	135 x 110	105 x 80/75	11		170	660 550	9688FTP125P63	00001603
	160	50	135 x 110	105 x 80/75	11		205	900 750	9688FTP160P63	00004609
	200	50	135 x 110	105 x 80/75	11		245	1200 1000	9688FTP200P63	00001002

Other Versions Of Polyurethane Wheels:



Ultratech Shore 92



Ultratech Hydro Shore 92



Ultratech Hydro Shore 92



Ultratech Shore 92



Ultratech Soft Shore 75

Technical Information

Housing and plate steel-welded, bright zinc plated, blue passivated, sealed single swivel double ball bearing, threaded king pin and locking nut secured, grease nipple, wheel axle with nut, plate fitting. Wheel centre made of Aluminium and tread consisting of Polyurethane, casted, precision ball bearing. Other tread options available!

Advantages at a glance

Roll performance	● ● ● ● ○
Movement noise	● ● ● ○ ○
Attrition	● ● ● ● ○
Corrosion resistance	● ● ● ○ ○

INTRALOGISTICS

Plate - Reinforced Pressed Steel, Polyurethane Casted Castors

High Load Capacity & Durability



The Zeta with Novatech has automatic alignment when picked up and an optimised roll resistance to lighten the load for the user. Additionally, the housing is made of extra heavy steel for a high capacity load.

 **Load capacity:** 500 - 800 kg

 **Temperature:** - 20 / + 60 °C

 **Overall height:** 164 - 240 mm

 **Wheel diameter:** 125 - 200 mm

	Wheel diameter [mm]	Width of Tread [mm]	Size of Plate [mm]	Plate hole centres [mm]	Plate hole [mm]	Offset [mm]	Overall height [mm]	Load capacity [kg]	Serial number	Order number
Swivel Castors 	125	50	137 x 105	105 x 80/75	11	55	164	500 400	4680ITP125P63 Flat	00600967
	160	50	137 x 105	105 x 80/75	11	55	200	800 640	4680ITP160P63 Flat	00003826
	200	50	137 x 105	105 x 80/75	11	55	240	800 640	4680ITP200P63 Flat	00004217
Swivel Castors with total lock 	125	50	137 x 105	105 x 80/75	11	60	164	500 400	4687ITP125P63 Flat	00600968
	160	50	137 x 105	105 x 80/75	11	55	200	800 640	4687ITP160P63 Flat	00600915
	200	50	137 x 105	105 x 80/75	11	55	240	800 640	4687ITP200P63 Flat	00601239
Fixed Castors 	125	50	137 x 117	105 x 80/75	11		164	500 400	4688ITP125P63 Flat	00600631
	160	50	137 x 117	105 x 80/75	11		200	800 640	4688ITP160P63 Flat	00600702
	200	50	137 x 117	105 x 80/75	11		240	800 640	4688ITP200P63 Flat	00601238

Other Versions Of Polyurethane Wheels:



Ultratech Shore 92



Ultratech Hydro Shore 92



Ultratech Hydro Shore 92



Ultratech Shore 92



Ultratech Soft Shore 75

Technical Information

Housing made of very heavy pressed steel, reinforced, bright zinc plated, blue passivated, sealed swivel double ball bearing, reinforced and heat-treated ball covers, riveted king pin, dust ring with integrated grease nipple, wheel axle with nut, plate fitting. Wheel centre made of Aluminium and tread consisting of Polyurethane, casted, precision ball bearing. Other tread options available!

Advantages at a glance

Roll performance	● ● ● ○ ○
Movement noise	● ● ● ○ ○
Attrition	● ● ● ● ○
Corrosion resistance	● ● ● ○ ○

MACHINERY & WORKSHOPS

Bolt Hole - Pressed Steel, Polyurethane Wheeled Castors

Compact Durability

The Agila with Novatech may be small, but it is highly durable and less maintenance. Additionally it is non-marking and suitable for sensitive floors.

 **Load capacity:** 100 kg

 **Temperature:** - 20 / + 60 °C

 **Overall height:** 58 mm

 **Wheel diameter:** 35 mm

	Wheel diameter [mm]	Width of Tread [mm]	Threaded stem [mm]		Offset [mm]	Overall height [mm]	Load capacity [kg]		Serial number	Order number
Swivel Castors	35	25	10 x 20		13,5	58	100		2470ETP035S50-M10x20	00028493



Technical Information

Swivel castor, housing made of pressed steel, bright zinc plated, blue passivated, double ball bearing swivel head, socket head cap screw, loose fitted. Wheel centre made of steel and tread consisting of Polyurethane, casted, precision ball bearing. Other tread options available!

Advantages at a glance

Roll performance	● ● ● ● ○
Movement noise	● ● ● ○ ○
Attrition	● ● ● ○ ○
Corrosion resistance	● ● ● ○ ○

MACHINERY & WORKSHOPS

Plate - Pressed Steel, Nylon Wheeled Castors

Durable Resistance



























The Alpha with Duratech is the perfect castor for those wanting less maintenance. It has abrasion-resistance tread and is durable even in cold weather. Additionally it can be easily steered and manoeuvre around bends and other obstacles.

 **Load capacity:** 200 - 350 kg

 **Temperature:** - 40 / + 80 °C

 **Overall height:** 108 - 240 mm

 **Wheel diameter:** 80 - 200 mm

	Wheel diameter [mm]	Width of Tread [mm]	Size of Plate [mm]	Plate hole centres [mm]	Plate hole [mm]	Offset [mm]	Overall height [mm]	Load capacity [kg]		Serial number	Order number
Swivel Castors											
	80	34	105 x 85	80/77 x 60	9	40	108	200		3470UOO080P62	00601054
	100	36	105 x 85	80/77 x 60	9	41	128	200		3470UOR100P62	00002710
	125	40	105 x 85	80/77 x 60	9	40	155	250		3470UOR125P62	00005185
	160	40	137 x 105	105 x 80/75	11	55	200	350		3470UOR160P63	00029874
	200	50	137 x 105	105 x 80/75	11	55	240	350		3470UOR200P63	00029868
Swivel Castors with total lock											
	80	34	105 x 85	80/77 x 60	9	44,5	108	200		3477UOO080P62	00005658
	100	36	105 x 85	80/77 x 60	9	41	128	200		3477UOR100P62	00006879
	125	40	105 x 85	80/77 x 60	9	40	155	250		3477UOR125P62	00003431
	160	40	137 x 105	105 x 80/75	11	60	200	350		3477UOR160P63	00029866
	200	50	137 x 105	105 x 80/75	11	55	240	350		3477UOR200P63	00029853
Fixed Castors											
	80	34	103 x 85	80/77 x 60	9		108	200		3478UOO080P62	00005659
	100	36	103 x 85	80/77 x 60	9		128	200		3478UOR100P62	00002711
	125	40	103 x 85	80/77 x 60	9		155	250		3478UOR125P62	00003430
	160	40	137 x 115	105 x 80/75	11		200	350		3478UOR160P63	00004875
	200	50	137 x 115	105 x 80/75	11		240	350		3478UOR200P63	00003029

Technical Information

Housing made of pressed steel, bright zinc plated, blue passivated, double ball bearing swivel head (excluding fixed version), wheel axle with nut, dust-guard and plate fitting. Wheel centre made of Polyamide and plain bearing (UOO) or roller bearing (UOR). Other tread options available!

Advantages at a glance

Roll performance	● ● ● ○ ○
Movement noise	● ● ● ○ ○
Attrition	● ● ● ● ●
Corrosion resistance	● ● ● ○ ○

MACHINERY & WORKSHOPS

Plate - Pressed Steel, Polyurethane Wheeled Castors

Industrial Design

The Alpha with Maxtech has a great for functional design and perfect everyday use. It is also extremely hard-wearing and can manoeuvre around easily with its double ball bearing swivel head.

 **Load capacity:** 350 kg

 **Temperature:** - 40 / + 80 °C

 **Overall height:** 200 - 240 mm

 **Wheel diameter:** 160 - 200 mm

	Wheel diameter [mm]	Width of Tread [mm]	Size of Plate [mm]	Plate hole centres [mm]	Plate hole [mm]	Offset [mm]	Overall height [mm]	Load capacity [kg]	Serial number	Order number
Swivel Castors	160	40	137 x 105	105 x 80/75	11	55	200	350	3470UAR160P63 red	00029633
	200	46	137 x 105	105 x 80/75	11	55	240	350	3470UAR200P63 red	00600946
Swivel Castors with total lock	160	40	137 x 105	105 x 80/75	11	60	200	350	3477UAR160P63 red	00030302
	200	46	137 x 105	105 x 80/75	11	55	240	350	3477UAR200P63 red	00600675
Fixed Castors	160	40	137 x 115	105 x 80/75	11		200	350	3478UAR160P63 red	00029638
	200	46	137 x 115	105 x 80/75	11		240	350	3478UAR200P63 red	00600947

Technical Information

Housing made of pressed steel, bright zinc plated, blue passivated, double ball bearing swivel head (excluding fixed version), wheel axle with nut, dust-guard and plate fitting. Wheel centre made of Polyamide and tread consisting of Polyurethane, roller bearing. Other tread options available!

Advantages at a glance





Roll performance	● ● ● ○ ○
Movement noise	● ● ● ○ ○
Attrition	● ● ● ● ○
Corrosion resistance	● ● ● ○ ○



MACHINERY & WORKSHOPS

Plate - Steel Welded, Polyurethane Casted Castors

Solid Stability

The Kappa with Novatech has guaranteed stability due to its two hardened double ball raceways. Additionally, it has a welded solid steel housing for high load capacities and an abrasion-resistant tread that is highly durable and requires less maintenance.

-  **Load capacity:** 550 - 1000 kg
-  **Temperature:** - 20 / + 60 °C
-  **Overall height:** 170 - 245 mm
-  **Wheel diameter:** 125 - 200 mm

	Wheel diameter [mm]	Width of Tread [mm]	Size of Plate [mm]	Plate hole centres [mm]	Plate hole [mm]	Offset [mm]	Overall height [mm]	Load capacity [kg]	Serial number	Order number
Swivel Castors 	125	50	135 x 110	105 x 80/75	11	48	170	660 550	9680FTP125P63	00001452
	160	50	135 x 110	105 x 80/75	11	58	205	900 750	9680FTP160P63	00001569
	200	50	135 x 110	105 x 80/75	11	59	245	1200 1000	9680FTP200P63	00001001
Swivel Castors with total lock 	125	50	135 x 110	105 x 80/75	11	48	170	660 550	9682FTP125P63	00002029
	160	50	135 x 110	105 x 80/75	11	58	205	900 750	9682FTP160P63	00004607
	200	50	135 x 110	105 x 80/75	11	59	245	1200 1000	9682FTP200P63	00001690
Fixed Castors 	125	50	135 x 110	105 x 80/75	11		170	660 550	9688FTP125P63	00001603
	160	50	135 x 110	105 x 80/75	11		205	900 750	9688FTP160P63	00004609
	200	50	135 x 110	105 x 80/75	11		245	1200 1000	9688FTP200P63	00001002

Other Versions Of Polyurethane Wheels:



Ultratech Shore 92



Ultratech Hydro Shore 92



Ultratech Hydro Shore 92



Ultratech Shore 92



Ultratech Soft Shore 75

Technical Information

Housing and plate steel-welded, bright zinc plated, blue passivated, sealed single swivel double ball bearing, threaded king pin and locking nut secured, grease nipple, wheel axle with nut, plate fitting. Wheel centre made of Aluminium and tread consisting of Polyurethane, casted, precision ball bearing. Other tread options available!

Advantages at a glance

Roll performance	● ● ● ● ○
Movement noise	● ● ● ○ ○
Attrition	● ● ● ● ○
Corrosion resistance	● ● ● ○ ○

MACHINERY & WORKSHOPS

Plate - Reinforced Pressed Steel, Polyurethane Casted Castors

High Load Capacity & Durability



The Zeta with Novatech has automatic alignment when picked up and an optimised roll resistance to lighten the load for the user. Additionally, the housing is made of extra heavy steel for a high capacity load.

 **Load capacity:** 500 - 800 kg

 **Temperature:** - 20 / + 60 °C

 **Overall height:** 164 - 240 mm

 **Wheel diameter:** 125 - 200 mm

	Wheel diameter [mm]	Width of Tread [mm]	Size of Plate [mm]	Plate hole centres [mm]	Plate hole [mm]	Offset [mm]	Overall height [mm]	Load capacity [kg]		Serial number	Order number
Swivel Castors 	125	50	137 x 105	105 x 80/75	11	55	164	500 400		4680ITP125P63 Flat	00600967
	160	50	137 x 105	105 x 80/75	11	55	200	800 640		4680ITP160P63 Flat	00003826
	200	50	137 x 105	105 x 80/75	11	55	240	800 640		4680ITP200P63 Flat	00004217
Swivel Castors with total lock 	125	50	137 x 105	105 x 80/75	11	60	164	500 400		4687ITP125P63 Flat	00600968
	160	50	137 x 105	105 x 80/75	11	55	200	800 640		4687ITP160P63 Flat	00600915
	200	50	137 x 105	105 x 80/75	11	55	240	800 640		4687ITP200P63 Flat	00601239
Fixed Castors 	125	50	137 x 117	105 x 80/75	11		164	500 400		4688ITP125P63 Flat	00600631
	160	50	137 x 117	105 x 80/75	11		200	800 640		4688ITP160P63 Flat	00600702
	200	50	137 x 117	105 x 80/75	11		240	800 640		4688ITP200P63 Flat	00601238

Other Versions Of Polyurethane Wheels:



Ultratech Shore 92



Ultratech Hydro Shore 92



Ultratech Hydro Shore 92



Ultratech Shore 92



Ultratech Soft Shore 75

Technical Information

Housing made of very heavy pressed steel, reinforced, bright zinc plated, blue passivated, sealed swivel double ball bearing, reinforced and heat-treated ball covers, riveted king pin, dust ring with integrated grease nipple, wheel axle with nut, plate fitting. Wheel centre made of Aluminium and tread consisting of Polyurethane, casted, precision ball bearing. Other tread options available!

Advantages at a glance

Roll performance	● ● ● ○ ○
Movement noise	● ● ● ○ ○
Attrition	● ● ● ● ○
Corrosion resistance	● ● ● ○ ○

WHEELS

Wheel - Foam Filled Wheel (Ø260)







Foam-Filled Durability

The Basetech Foam is durable solution for those in an outdoor environment or in an atmosphere where abrasions may occur. This tyre can be punctured, but still remain intact.

 **Load capacity:** 75 kg

 **Temperature:** °C

 **Wheel diameter:** 260 mm

Description	Wheel diameter [mm]	Width of Tread [mm]	Axle Hole-Ø [mm]	Hub length [mm]	Load capacity [kg]	Serial number	Order number
							
	260	75	20	74	75	PNR260x75-Ø20 HL74 TFR	00604386
	260	75	25	74	75	PNR260x75-Ø25 HL74 TFR	00603060

Technical Information

Wheel centre made of Polypropylene and tread consisting of Polyurethane, foamed with roller bearing.

Advantages at a glance

Roll performance	● ● ● ○ ○
Movement noise	● ● ● ○ ○
Attrition	● ● ● ○ ○
Corrosion resistance	● ● ● ○ ○

WHEELS

Wheel - Elastic Tyre Wheels (Ø100 - Ø200)



Safe Transportation

The Elastech is a quiet running application with smooth handling capabilities. It also allows for minimal vibration, which in return protects goods that are being transported.

 **Load capacity:** 160 - 400 kg

 **Temperature:** - 20 / + 80 °C

 **Wheel diameter:** 100 - 200 mm

	Wheel diameter [mm]	Width of Tread [mm]	Axle Hole-Ø [mm]	Hub length [mm]	Load capacity [kg]	Serial number	Order number
	100	34	12	44,4	160	UFR100x34-Ø20 Blue	00002439
	125	40	12	44,4	250	UFR125x40-Ø20 Blue	00003287
	100	34	12	44,4	160	UFR100x34-Ø20 Grey	00001602
	125	40	12	44,4	250	UFR125x40-Ø20 Grey	00025760
	160	40	12	58	300	UFR160x40-Ø20 Grey	00025311
	200	40	12	58	400	UFR200x40-Ø20 Grey	00023476

Technical Information

Wheel centre made of Polyamide and tread consisting of elastic-tyre, non-marking, roller bearing.

Advantages at a glance

Roll performance	● ● ● ○ ○
Movement noise	● ● ● ● ●
Attrition	● ● ● ○ ○
Corrosion resistance	● ● ● ○ ○

WHEELS

Wheel - Elastic Tyre Wheels (Ø100 - Ø200)

Prevent Vibration & Noise

The Elastech is the perfect wheel for smooth handling and easy manoeuvrability. Additionally it prevents vibration and reduces noise.

 **Load capacity:** 200 - 450 kg

 **Temperature:** - 20 / + 85 °C

 **Wheel diameter:** 100 - 200 mm

Description	Wheel diameter [mm]	Width of Tread [mm]	Axle Hole-Ø [mm]	Hub length [mm]	Load capacity [kg]	Serial number	Order number
	100	40	8	45	200	IEP100x40-Ø8 HL45	00002341
	125	50	20	60	300	IEP125x50-Ø20	00001254
	160	50	20	60	350	IEP160x50-Ø20	00001035
	200	50	20	60	450	IEP200x50-Ø20	00003609

Technical Information

Wheel centre made of Aluminium and tread consisting of black elastic-tyre, vulcanised, precision ball bearing.

Advantages at a glance



Roll performance	● ● ● ○ ○
Movement noise	● ● ● ○ ○
Attrition	● ● ● ○ ○
Corrosion resistance	● ● ● ○ ○

WHEELS

Wheel - Heat Resistant Elastic Tyre Wheels (Ø100)

Constant Heat Resistance

The Elastech Heat is ideal for temperatures ranging from -30° to +250°. Additionally it's aluminium wheel centre makes it lightweight, but also extremely durable for transporting goods.

-  **Load capacity:** 80 kg
-  **Temperature:** - 30 / + 250 °C
-  **Wheel diameter:** 100 mm

Description	Wheel diameter [mm]	Width of Tread [mm]	Axle Hole-Ø [mm]	Hub length [mm]	Load capacity [kg]	Serial number	Order number
	100	35	8	45	80	IDG100x35-Ø8	00033962



Technical Information

Wheel centre made of Aluminium and tread consisting of heat resisting silicone rubber, damping, self-lubricating bushing.

Advantages at a glance

Roll performance	● ● ● ○ ○
Movement noise	● ● ● ○ ○
Attrition	● ● ● ○ ○
Corrosion resistance	● ● ● ● ●

WHEELS

Wheel - Nylon Wheels (Ø80 - Ø200)







Less Maintenance, More Durability

The Duratech wheel has an ideal manoeuvrability and a smooth running and swivel performance. Additionally it is particularly durable and require little maintenance.

 **Load capacity:** 200 - 600 kg

 **Temperature:** - 40 / + 80 °C

 **Wheel diameter:** 80 - 200 mm

Description	 Wheel diameter [mm]	 Width of Tread [mm]	 Axle Hole-Ø [mm]	 Hub length [mm]	 Load capacity [kg]	Serial number	Order number
	80	34	12	44,4	200	U00080x34-Ø12	00001507
	100	36	12	44,4	200	U00100x36-Ø12	00001720
	125	40	12	44,4	300	U00125x40-Ø12 HL 44,4	00001663
	160	40	20	58	500	U00160x40-Ø20	00001874
	200	46	20	58	600	U00200x46-Ø20	00001775

Technical Information

Wheel centre made of Polyamide with plain bearing.

Advantages at a glance

Roll performance	● ● ● ○ ○
Movement noise	● ● ● ○ ○
Attrition	● ● ● ● ●
Corrosion resistance	● ● ● ○ ○

WHEELS

Wheel - Nylon Wheels (Ø80 - Ø200)



Indestructible Stability

The Duratech wheel has high pressure stability and is virtually indestructible. Additionally, it has an enhanced running comfort and is extremely durable even in cold weather.

 **Load capacity:** 600 - 1000 kg

 **Temperature:** - 40 / + 80 °C

 **Wheel diameter:** 82 - 200 mm

	Wheel diameter [mm]	Width of Tread [mm]	Axle Hole-Ø [mm]	Hub length [mm]	Load capacity [kg]	Serial number	Order number
 Description	100	50	20	60	600	TOP100x50-Ø20	00014600
	125	50	20	60	700	TOP125x50-Ø20	00001133
	160	50	20	60	850	TOP160x50-Ø20	00001134
	200	50	20	60	1000	TOP200x50-Ø20	00000916
 Description	82	60	20	64	600	TOP082x60-Ø20	00030230
	82	70	20	70	750	TOP082x70-Ø20 HL70	00030490
	82	75	20	77	750	TOP082x75-Ø20	00030590
	82	91	20	93	900	TOP082x91-Ø20 HL93	00030830
	82	100	20	102	900	TOP082x100-Ø20	00030290

Technical Information

Wheel centre made of Polyamide, heavy duty, precision ball bearing. Higher load capacities on a smooth, even surface.

Advantages at a glance

Roll performance	● ● ● ● ●
Movement noise	● ● ● ○ ○
Attrition	● ● ● ● ●
Corrosion resistance	● ● ● ○ ○

WHEELS

Wheel - Heat Resistant Synthetic Wheels (Ø80 & Ø100)







Extreme Heat Resistance

The Duratech Heat can withstand extreme temperatures that range from -40° to +280°. This makes in at ideal solution for those working in the food and catering industries. Additionally it is durable and easy to clean.

 **Load capacity:** 100 - 125 kg

 **Temperature:** - 40 / + 280 °C

 **Wheel diameter:** 80 - 100 mm

Description	Wheel diameter [mm]	Width of Tread [mm]	Axle Hole-Ø [mm]	Hub length [mm]	Load capacity [kg]	Serial number	Order number
							
	80	35	12	43,5	100	BOG080x35-Ø12	00028373
	100	35	11,1	43,5	125	BOG100x35-Ø11.1	00035343

Technical Information

Wheel made of heat resisting synthetic material, self-lubricating bushing.

Advantages at a glance

Roll performance	● ● ● ○ ○
Movement noise	● ● ● ○ ○
Attrition	● ● ● ● ●
Corrosion resistance	● ● ● ● ●

WHEELS

Wheel - Polyurethane Wheels (Ø80 - Ø200)







Industrial Manoeuvrability

The Maxtech is an ideal solution for those requiring a high degree of manoeuvrability with an industrial weight load. Additionally, this wheel is also extremely hard-wearing.

 **Load capacity:** 100 - 500 kg

 **Temperature:** - 40 / + 80 °C

 **Wheel diameter:** 80 - 200 mm

Description	Wheel diameter [mm]	Width of Tread [mm]	Axle Hole-Ø [mm]	Hub length [mm]	Load capacity [kg]	Serial number	Order number
							
	80	32	12	44,4	100	UAR080x32-Ø12 HL44,4 red	00603891
	100	32	12	44,4	150	UAR100x32-Ø12 HL44,4 red	00603887
	125	32	12	44,4	200	UAR125x32-Ø12 HL44,4 red	00603888
	160	40	20	58	350	UAR160x40-Ø20 HL58 red	00603889
	200	50	20	58	500	UAR200x50-Ø20 HL58 red	00603890

Technical Information

Wheel centre made of Polyamide, Tread: Polyurethane, roller bearing.

Advantages at a glance

Roll performance	● ● ● ○ ○
Movement noise	● ● ● ○ ○
Attrition	● ● ● ● ○
Corrosion resistance	● ● ● ○ ○

WHEELS

Wheel - Heavy Duty Polyurethane Wheels (Ø100 - Ø200)



Highly Resilient

The Novatech is a suitable for harsh operating conditions. The tread material is cut and abrasion resistant and they require little maintenance.

 **Load capacity:** 300 - 800 kg

 **Temperature:** - 20 / + 60 °C

 **Wheel diameter:** 100 - 200 mm

Description	Wheel diameter [mm]	Width of Tread [mm]	Axle Hole-Ø [mm]	Hub length [mm]	Load capacity [kg]	Serial number	Order number
	100	40	8	45		ITP100x40-Ø8 HL45	00030827
	125	50	20	60	500 400	ITP125x50-Ø20 flat	00000948
	160	50	20	60	800 640	ITP160x50-Ø20 flat	00803678
	200	50	20	60	800 640	ITP200x50-Ø20 flat	00601596

Technical Information

Wheel centre made of Aluminium and tread consisting of Polyurethane, casted with precision ball bearing.

Advantages at a glance

Roll performance	● ● ● ○ ○
Movement noise	● ● ● ○ ○
Attrition	● ● ● ● ○
Corrosion resistance	● ● ● ○ ○

WHEELS

Wheel - Heavy Duty Polyurethane Wheels (Ø100 - Ø200)







Highly Resilient

The Novatech is a suitable for harsh operating conditions. The tread material is cut and abrasion resistant and they require little maintenance.

 **Load capacity:** 550 - 1200 kg

 **Temperature:** - 20 / + 60 °C

 **Wheel diameter:** 125 - 200 mm

Description	Wheel diameter [mm]	Width of Tread [mm]	Axle Hole-Ø [mm]	Hub length [mm]	Load capacity [kg]	Serial number	Order number
							
	125	50	20	60	540 450	FTP125x50-Ø20 HL60	00000994
	160	50	20	60	900 750	FTP160x50-Ø20 HL60	00600050
	200	50	20	60	1200 1000	FTP200x50-Ø20 HL60	00600051

Technical Information

Wheel centre made of cast iron and tread consisting of Polyurethane, casted with precision ball bearing.

Advantages at a glance

Roll performance	● ● ● ● ○
Movement noise	● ● ● ○ ○
Attrition	● ● ● ● ○
Corrosion resistance	● ● ● ○ ○

WHEELS

Wheel - Rubber Wheels (Ø100 - Ø200)







Clean & Robust

The Puretech has a solid rubber tread that is extremely robust, yet non-marking which is suitable for those that have sensitive flooring or those that want clean a floor.

 **Load capacity:** 70 - 205 kg

 **Temperature:** - 20 / + 60 °C

 **Wheel diameter:** 100 - 200 mm

Description	Wheel diameter [mm]	Width of Tread [mm]	Axle Hole-Ø [mm]	Hub length [mm]	Load capacity [kg]	Serial number	Order number
							
	100	30	12	44,4	70	DVR100x30-Ø12	00031147
	125	37	12	44,4	100	DVR125x37-Ø12	00004921
	160	40	20	58	135	DVR160x40-Ø20	00002901
	200	50	20	58	205	DVR200x50-Ø20	00001375

Technical Information

Wheel centre made of pressed steel, Tread: solid rubber, black, roller bearing.

Advantages at a glance

Roll performance	● ● ● ○ ○
Movement noise	● ● ● ○ ○
Attrition	● ● ○ ○ ○
Corrosion resistance	● ● ● ○ ○

WHEELS

Wheel - Rubber Wheels (Ø100 - Ø200)

Electrically Conductive & Robust

The Puretech has a solid rubber tread that is extremely robust, yet non-marking which is suitable for those that have sensitive flooring or those that want clean a floor. Additionally this castor is electrically conductive making it an ideal solution for those that need to avoid electrostatic discharge.

 **Load capacity:** 70 - 205 kg

 **Temperature:** - 20 / + 60 °C

 **Wheel diameter:** 100 - 200 mm

Description	Wheel diameter [mm]	Width of Tread [mm]	Axle Hole-Ø [mm]	Hub length [mm]	Load capacity [kg]	Serial number	Order number
	100	30	12	44,4	70	DYR100x30-Ø12	00006567
	125	37	12	44,4	100	DYR125x37-Ø12	00006571
	160	40	20	58	135	DYR160x40-Ø20	00006532
	200	50	20	58	205	DYR200x50-Ø20	00006572

Technical Information

Wheel centre made of pressed steel, Tread: solid rubber, black, electrically conductive, roller bearing.

Advantages at a glance

Roll performance	● ● ● ○ ○
Movement noise	● ● ● ○ ○
Attrition	● ● ● ○ ○
Corrosion resistance	● ● ● ○ ○

WHEELS

Wheel - Thermoplastic Rubber Wheels (Ø50 - Ø125)





Excellent Performance

The Supratech has outstanding manoeuvrability and mobility. This wheel is also very low maintenance and extremely hygienic due to its ability to be washed.

 **Load capacity:** 40 - 100 kg

 **Temperature:** - 20 / + 60 °C

 **Wheel diameter:** 50 - 125 mm

	Wheel diameter [mm]	Width of Tread [mm]	Axle Hole-Ø [mm]	Hub length [mm]	Load capacity [kg]	Serial number	Order number
 Description	50	19	6	21,5	40	PJI050x19-Ø6	00004002
 Description	50	19	8	21	40	PJO050x19-Ø8	00003750
	75	25	8	26,5	75	PJO075x25-Ø8	00005176
	100	32	12	34,9	80	PJO100x32-Ø12	00026461
	125	32	12	34,9	100	PJO125x32-Ø12	00003187
 Description	75	25	8	28,4	75	PJP075x25-Ø8	00026499
	100	32	8	36,5	100	PJP100x32-Ø8	00026459
	125	32	8	36,5	100	PJP125x32-Ø8 Shore D40	00026717
 Description	50	20	8	22	50	YGO050x20-Ø8	00031212
	75	25	8	26,5	75	YGO075x25-Ø8	00006363
	100	32	12	34,9	80	YGO100x32-Ø12	00028829

Technical Information

Tread: TENTEprene (thermoplastic rubber)

PJI: Wheel centre made of Polypropylene, grey non-marking, plain bearing.

PJO: Wheel centre made of Polypropylene, grey non-marking with plain bearing.

PJP: Wheel centre made of Polypropylene, grey non-marking, precision ball bearing.

YGO: Wheel centre made of Polypropylene, electric conductive, grey non-marking, plain bearing.

Advantages at a glance





Roll performance	● ● ● ○ ○
Movement noise	● ● ● ○ ○
Attrition	● ● ● ○ ○
Corrosion resistance	● ● ● ○ ○





FITTINGS

Stems - Threaded, Circlip Stem, Round & Square Expanders

Variety of Fittings

Includes: Round Expanding Fittings (R07), Square Expanding Fittings (R47), Threaded Stem with Hexagon Neck (S70) & Stem with Circlip (B10)

-  **Load capacity:** 40 - 80 kg
-  **Temperature:** °C
-  **Overall height:** 6 mm
-  **Wheel diameter:**

	Threaded stem [mm]	Overall height [mm]	Load capacity [kg]	Serial number	Order number
	M 8 x 15	6	40	S70-8x15 / 8	00071932
	M 8 x15	6	50	S70-8x15 / 10	00074385
	M 10 x 15	6	40	S70-10x15 / 8	00071940
	M 10 x 15	6	80	S70-10x15 / 10	00071927
	11 x 20	4,5	40	B10-11x20 / 8	00072202
	11 x 20	4,5	60	B10-11x20 / 10	00072200
	19 - 21,5			R07-Ø19-21,5	00600053
	21,5 - 24			R07-Ø21,5-24	00017481
	24 - 27			R07-Ø24-27	00600108
	27 - 30			R07-Ø27-30	00005536
	21,5 - 24			R47-21,5-24	00005160
	24 - 27			R47-24-27	00005033
	27 - 30			R47-27-30	00006568





Advantages at a glance

Roll performance	○ ○ ○ ○ ○
Movement noise	○ ○ ○ ○ ○
Attrition	○ ○ ○ ○ ○
Corrosion resistance	● ● ● ○ ○

FITTINGS

Plate - Push-in Plate Fittings

Plate fitting

-  **Load capacity:** 40 - 100 kg
-  **Temperature:** °C
-  **Overall height:** 10 - 12 mm
-  **Wheel diameter:**



Size of Plate [mm]	Plate hole centres [mm]	Plate hole [mm]	Overall height [mm]	Load capacity [kg]	Serial number	Order number
38 x 38	27 x 27	5	10	40	P41-38x38 / 8	00072238
38 x 38	27 x 27	5		60	P41-38x38 / 10	00072255
42 x 42	32 x 32	5		60	P41-42x42 / 10	00074173
65 x 65	47/42 x 47/42	6	12	100	P41-65x65 / 11	00072250

Advantages at a glance

Roll performance	○ ○ ○ ○ ○
Movement noise	○ ○ ○ ○ ○
Attrition	○ ○ ○ ○ ○
Corrosion resistance	● ● ● ○ ○

APPLICATION INDEX

Recline Chairs	Page 15, 21, 22 24, 28	Scene Shifter	Pages 109
Bedside Table	Page 15, 19, 20, 21 26, 27, 28	Tool Carts	Pages 67, 78, 79, 83
Tables	Page 16, 17, 21, 23 24, 28, 29	Platform Trolley	Pages 75, 76, 78, 79, 81, 82, 83
TV Stand	Pages 17, 23, 29	Board Trolley	Pages 113, 115, 116, 117, 118, 120
Pedestals	Pages 32, 33, 34, 39, 46	Mobile Waste Bins	Pages 112, 113, 118
Work stations	Pages 33, 40, 41, 47, 49, 69, 70, 71 72, 73	Medium Duty Trolleys	Pages 73, 75, 76, 77, 78, 79, 80, 81, 82, 83
Shelving	Pages 30, 33, 37, 39, 41, 42, 45, 46, 47, 62, 69, 70	Canteen Equipment	Pages 84, 86, 89, 90, 92, 93, 94, 95
Display Stands/Racks	Pages 30, 32, 33, 35, 36, 37, 39, 41, 43, 44, 46, 47	Bakery Racks	Pages 86, 89, 90, 92, 93
WhiteBoards	Pages 17, 18	Sorting Trolleys	Pages 76, 77, 78, 81, 82
Flip charts	Pages 17, 18, 23, 29	Laundry Carts	Pages 73, 76, 77, 78, 81
Garment Rails	Pages 33	Stage Equipment	Pages 73, 74, 76, 77, 78, 79, 80, 81, 82, 83, 119
Library Carts	Pages 33, 37, 41, 45	Flight Cases	Pages 73, 76, 77, 78
Dollies	Pages 48, 49, 62, 69, 70, 71, 72, 74	Transport Trolleys	Pages 79, 81, 82, 83, 119
Rollcages	Pages 73, 74, 75, 76, 77, 78, 79, 81	Towed Trolleys	Pages 115, 118, 120
Office Chairs	Pages 17	Working Platforms	Pages 124, 125
Office Desks	Pages 17, 23, 29	Machine Construction	Pages 122, 124, 125
Shopfitting Systems	Pages 33, 34, 35, 36, 37, 39, 40, 41, 42, 43, 44, 45, 46, 48, 49, 71, 72	Heavy Mobile Jigs	Pages 124, 125
Mobile Shelving	Pages 33, 37, 39, 40, 41, 45, 46, 47, 48, 49, 71, 72	Wheels	Pages 127-138
Light Transport Trolley	Pages 33, 37, 41, 45, 47, 48, 98	Castor Fixings	Pages 139, 140
Cabinets	Pages 15, 19, 20, 21, 26, 28		
Bookcase	Pages 71, 72		
Filing Cabinets	Pages 15, 17		
Office Trolley	Pages 17, 21, 24, 28, 48		
Draw glides	Pages 25		
Drip stands	Pages 18, 50		
Serving Trolleys	Pages 88, 89		
Food Carts	Pages 86, 88, 89		
Lab equipment	Pages 49, 50, 52 53, 54, 55, 56, 57, 99, 101, 102, 107, 108		
Overbed Tables	Pages 15, 16, 17		



FOR EVERY REQUIREMENT THE RIGHT SERVICE



CAD SERVICE – SIMPLE & FAST

With our CAD service you save valuable working time and increase the efficiency of your development processes. The diverse TENTE product world is available to you quickly and conveniently, around the clock in our online library.

We support your design and development department with numerous 2D and 3D file formats and can also advise you if necessary by our teams.

OUR TEST CENTRE – MONITORING CRUCIAL BENCHMARKS

The everyday use of wheels and rollers does not comply with standards. As a result, test requirements often far exceed those of application-specific standards. Whether wheel, roller or single component, in our test laboratories each part has to withstand significantly increased demands. So we test the test pieces among others in a temperature chamber. There, the products are subjected to a wide variety of tensile and compression tests under the influence of extreme temperatures. In addition, we also control the static and dynamic load capacity above the norm. The same applies to the changing loads in continuous swivel and approach tests. The interaction of the products with the substrate is tested on a customer-specific basis on a wide variety of coverings. Outstanding durability and reliability must be proven by our rollers and wheels when analyzing the abrasion volume as well as in aggressive salt spray tests. The result is solutions that impress with premium quality and demonstrably improve the mobility of your application.



TRADING SUPPORT – QUALITY ON DEMAND

Our proven standard products for specialist retailers are normally always available in stock and available on short notice. This gives you access to the required goods at any time. For the compilation of a high-turnover assortment, our competent sales staff with extensive market knowledge are at your side.



CONTACT

TENTE Castors Ltd.
100 Papyrus Road, Werrington Parkway
GB-Peterborough PE4 5HN
enquiry.uk@tente.com
www.tente.co.uk
T+44 (0)1733 578111

