

LEVINA STAINLESS

5381PJC125P30-13 XL

EAN 4031582382105



BETTER MOBILITY. BETTER LIFE.



Image may differ from the original product

PERFORMANCE

Roll performance	●●●○○
Movement noise	●●●●○
Attrition	●●●●○
Corrosion resistance	●●●●○

CORE ATTRIBUTES

Product name	Levina stainless
Type	Swivel castor with directional lock
Standard	EN12530 - Devices Castors
Load capacity at 1.8 mph	220.46 lb
Stainless	✓
Load capacity Static	440.92 lb
Temperature range (Minimum)	14 °F
Temperature range (Maximum)	104 °F
Overall height	6.34 in
Overall weight	1.31 lb

WHEEL

Body material	Polypropylene
Tread material	Thermoplastic rubber
Bearing	Precision ball bearing, stainless
Threadguards	With threadguard
Diameter	4.92 in
Tread width	1.26 in
Hardness of tread (A)	87 Shore A

HOUSING

Material	Polyamide
Fork shape	Slim
Swivel bearing	Two ball races, reinforced or stainless
Offset	1.52 in
Swivel radius	5.12 in
Swivel interference	10.24 in

FITTING

Fitting type	Bolt hole
Bolt hole diameter	0.51 in



Universal Design Award



Deutscher Designer Club

LEVINA STAINLESS

5381PJC125P30-13 XL

EAN 4031582382105



BETTER MOBILITY. BETTER LIFE.

TECHNICAL DRAWINGS

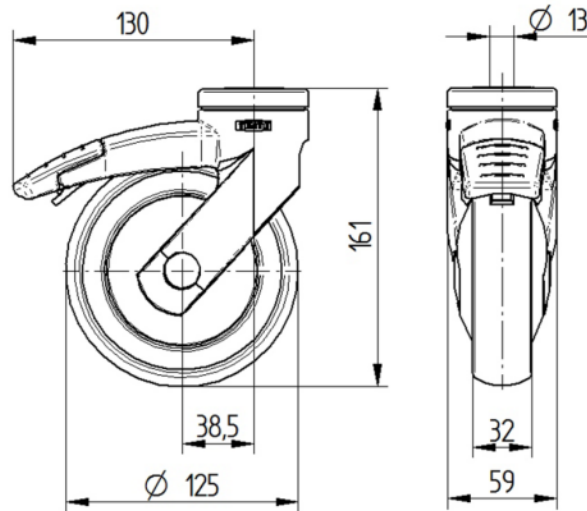

Universal
Design
Award



Deutscher
Designer
Club