

LEVINA

5377PIO125P30-13 XL

EAN 4031582382280



BETTER MOBILITY. BETTER LIFE.



Afbeelding kan verschillen van het oorspronkelijke product

PRESTATIES

Rolprestaties	● ● ● ○ ○
Bewegingsgeluid	● ● ● ● ○
Verloop	● ● ● ● ○
Corrosieweerstand	● ● ● ● ○

KERNKENMERKEN

Productnaam	Levina
Type	Zwenkwiel met dubbele rem
Standaard	EN12530 - Apparaten zwenkwielen
Draagvermogen bij 3 km/u	80 kg
Statisch Draagvermogen	160 kg
Temperatuurbereik (minimaal)	-10 °C
Temperatuurbereik (maximaal)	40 °C
Totale hoogte	161 mm
Totaal gewicht	0,596 kg

WIEL

Wielkern materiaal	Polypropyleen
Materiaal loopvlak	Massief rubber, niet-markerend
Lager	Glijlager
Afdekkapjes	Zonder afdekkapjes
Diameter	125 mm
Breedte Loopvlak	32 mm
Hardheid van het loopvlak (A)	80 Shore A

VORK

Materiaal	Polyamide
Vork Vorm	Slank
Zwenklager	Dubbele kogeldraaikrans
Offset	38,5 mm
Zwenk radius	130 mm
Uitzwenking	260 mm

BEVESTIGING

Type bevestiging	Boutgat
Diameter boutgat diameter	13 mm

Universele
Design
AwardDuitse
OntwerpersClub

LEVINA

5377PIO125P30-13 XL

EAN 4031582382280



BETTER MOBILITY. BETTER LIFE.

TECHNISCHE TEKENINGEN

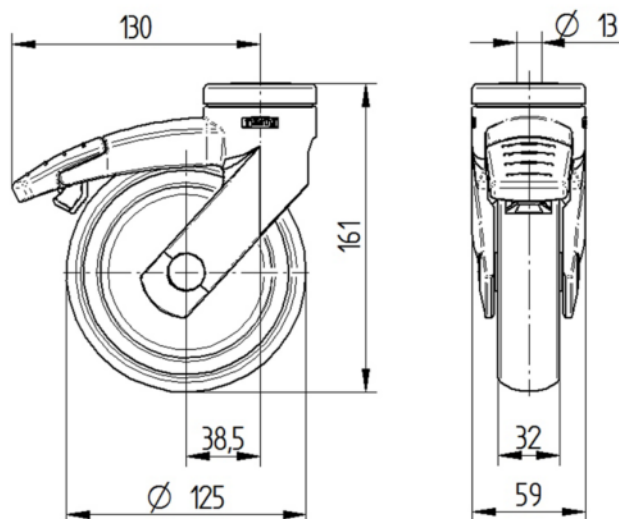

Universele
Design
Award



Duitse
OntwerpersClub