

NOVATECH

FTP 400x100-Ø40 HL120

EAN 4031582319491



BETTER MOBILITY. BETTER LIFE.



Image may differ from the original product

WHEEL

Body material	Cast iron
Tread Material Mix	Polyurethane, casted
Bearing	Precision ball bearing
Wheel Color	Honey yellow (RAL1005)
Threadguards	With threadguard
Diameter	400 mm
Tread width	100 mm
Axle Hole Diameter	40 mm
Hub Length	120 mm
Body width	100 mm
Hardness of tread (A)	92 Shore A
Hardness of tread (D)	42 Shore D

PERFORMANCE

Roll Performance	●●●●○
Movement Noise	●●●○○
Attrition	●●●●○
Corrosion Resistance	●●●○○

CORE ATTRIBUTES

Product Name	Novatech
Type	Wheel
Standard	EN12533 - Heavy Duty Castors
Load capacity at 4 km/h	3840 kg
Load capacity at 6 km/h	3200 kg
Electric Conductive	No
Stainless	No
Load capacity Static	6400 kg
Temperature range (Minimum)	-10 °C
Temperature range (Maximum)	60 °C
Overall weight	28.24 kg

NOVATECH

FTP 400x100-Ø40 HL120

EAN 4031582319491

Order number 00801334
Product Drawings



BETTER MOBILITY. BETTER LIFE.

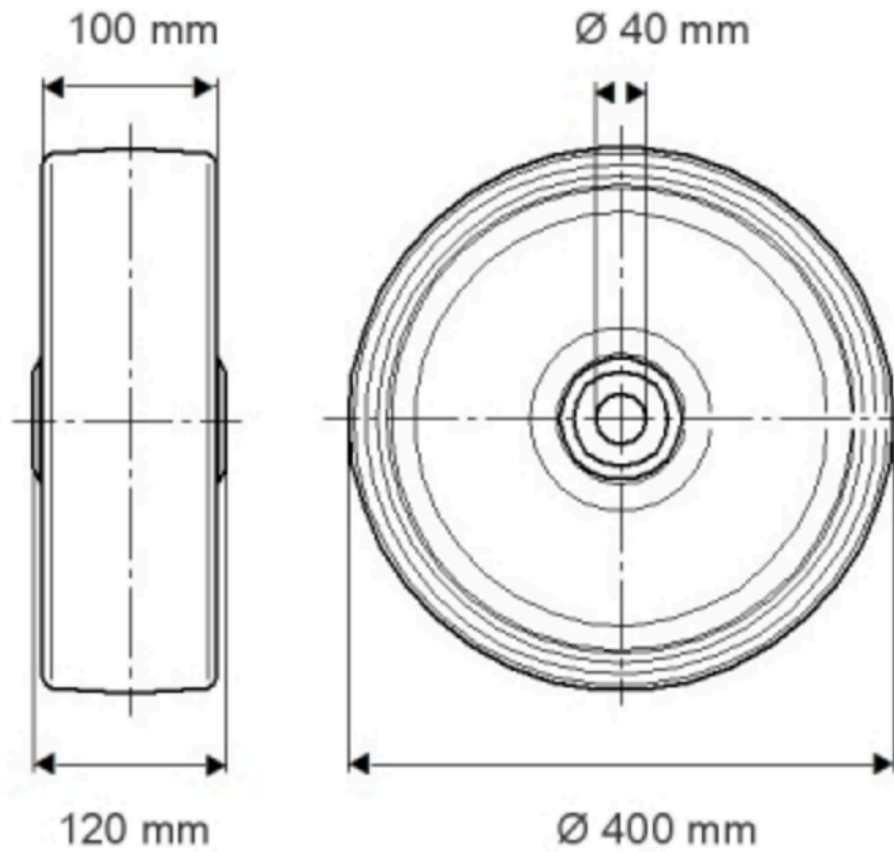

PRODUCT INFORMATION

NOVATECH

FTP 400x100-Ø40 H1.120

EAN 4031582319481

Order number 00801334

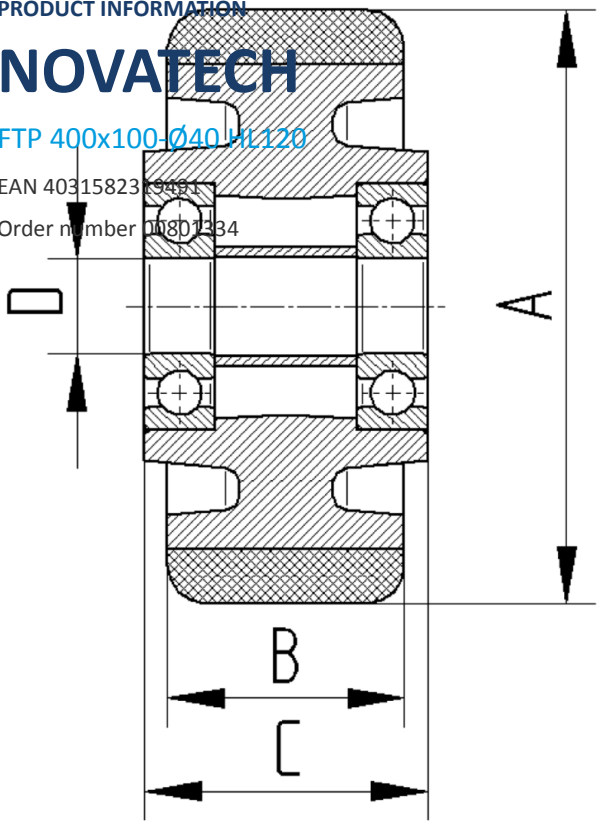

BETTER MOBILITY. BETTER LIFE.