

ALPHA

3470BOG080P62

EAN 4031582345698



BETTER MOBILITY. BETTER LIFE.



Image may differ from the original product

PERFORMANCE

Roll Performance	●●●●○
Movement Noise	●●●○○
Attrition	●●●●●
Corrosion Resistance	●●●●●

CORE ATTRIBUTES

Product Name	Alpha
Type	Swivel castor
Standard	EN12532 - Transport Equipment
Load capacity at 4 km/h	100 kg
Electric Conductive	No
Stainless	No
Load capacity Static	200 kg
Temperature range (Minimum)	-40 °C
Temperature range (Maximum)	280 °C
Overall Height	108 mm
Overall weight	0.68 kg

HOUSING

Housing Material	Steel sheet, heavy
Fork shape	Broad
Swivel Bearing	Two ball races
Housing Color	Blue passivated
Offset	40 mm
Swivel radius	80 mm
Swivel interference	160 mm

WHEEL

Body material	Plastic thermoset, heat-resistant
Tread Material Mix	Identical with wheel body
Bearing	Dry bearing bush
Axle	Screwed with nut
Diameter	80 mm
Tread width	35 mm
Hardness of tread (D)	85 Shore D

FITTING

Fitting type	Small rectangular plate
Plate length	105 mm
Plate width	80 mm
Plate hole length (Minimum)	77 mm
Plate hole length (Maximum)	80 mm
Plate hole width (Maximum)	60 mm
Plate hole diameter	9 mm

ALPHA

3470BOG080P62

EAN 4031582345698



BETTER MOBILITY. BETTER LIFE.

Product Drawings

3470U00080P62-neu

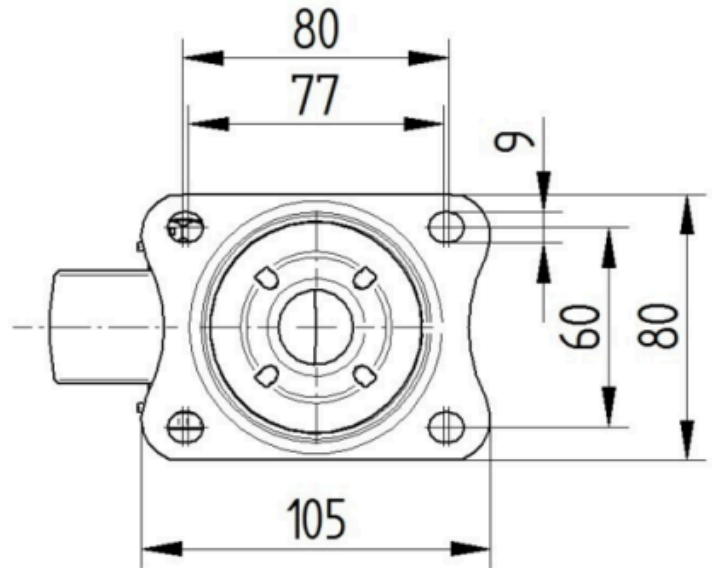
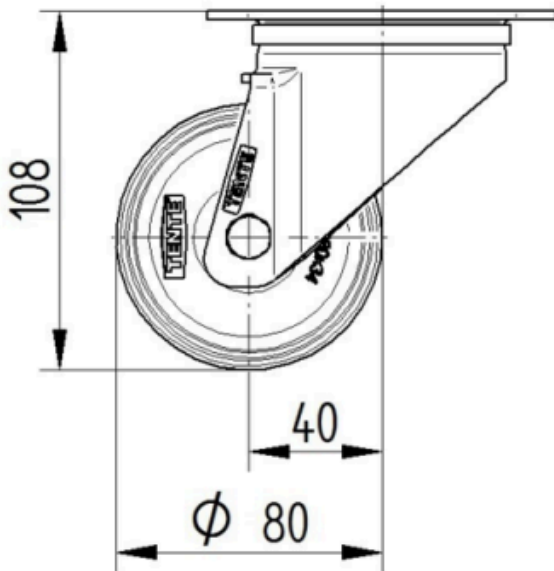

Platte 3470-080P62-105x80

