

LEVINA

5370PIP100R05-28X45

EAN 4031582362749



BETTER MOBILITY. BETTER LIFE.



Image may differ from the original product

PERFORMANCE

Roll performance	●●●○○
Movement noise	●●●●●
Attrition	●●●○○
Corrosion resistance	●●●●●

CORE ATTRIBUTES

Product name	Levina
Type	Swivel castor
Standard	EN12530 - Devices Castors
Load capacity at 3 km/h	80 kg
Load capacity Static	160 kg
Temperature range (Minimum)	-10 °C
Temperature range (Maximum)	40 °C
Overall height	137 mm

WHEEL

Body material	Polypropylene
Tread hardness	soft
Tread material	Solid rubber, non-marking
Bearing	Precision ball bearing
Threadguards	With threadguard
Diameter	100 mm
Tread width	32 mm
Hardness of tread (A)	75 Shore A

HOUSING

Material fork	Polyamide
Fork shape	Slim
Swivel bearing	Two ball races
Offset	36 mm
Swivel radius	86 mm
Swivel interference	172 mm

FITTING

Fitting type	Solid stem, round
Bolt diameter	28 mm
Bolt length	45 mm



Universal Design Award



Deutscher Designer Club

LEVINA

5370PIP100R05-28X45

EAN 4031582362749



BETTER MOBILITY. BETTER LIFE.

TECHNICAL DRAWINGS

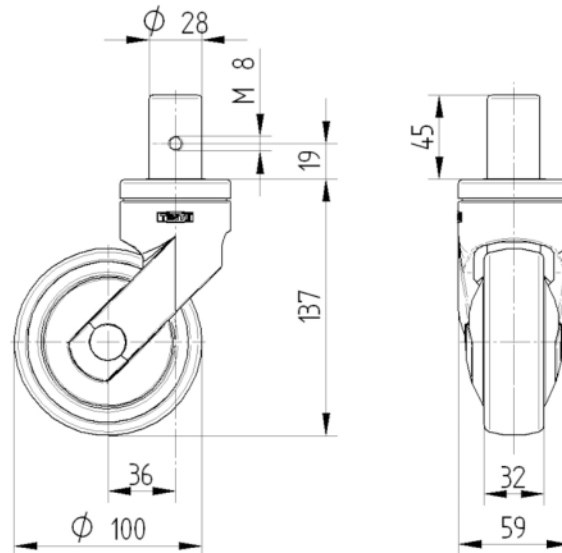

Universal
Design
Award



Deutscher
Designer
Club