

DURATECH

MOP 100x50-Ø20

EAN 4031582320008



BETTER MOBILITY. BETTER LIFE.



Image may differ from the original product

WHEEL

Body material	Polyamide, super heavy
Tread Material Mix	Identical with wheel body
Bearing	Precision ball bearing
Wheel Color	Natural white
Threadguards	Without threadguard
Diameter	100 mm
Tread width	50 mm
Axle Hole Diameter	20 mm
Hub Length	60 mm
Body width	50 mm
Hardness of tread (D)	75 Shore D
Bearing type	6304

PERFORMANCE

Roll Performance	● ● ● ● ●
Movement Noise	● ● ○ ○ ○
Attrition	● ● ● ● ●
Corrosion Resistance	● ● ● ○ ○

CORE ATTRIBUTES

Product Name	Duratech
Type	Wheel
Standard	EN12533 - Heavy Duty Castors
Load capacity at 4 km/h	1680 kg
Load capacity at 6 km/h	1400 kg
Electric Conductive	No
Stainless	No
Load capacity Static	2800 kg
Temperature range (Minimum)	-40 °C
Temperature range (Maximum)	80 °C
Overall weight	0.7 kg

DURATECH

MOP 100x50-Ø20

EAN 4031582320008

Order number 00801258
Product Drawings



BETTER MOBILITY. BETTER LIFE.

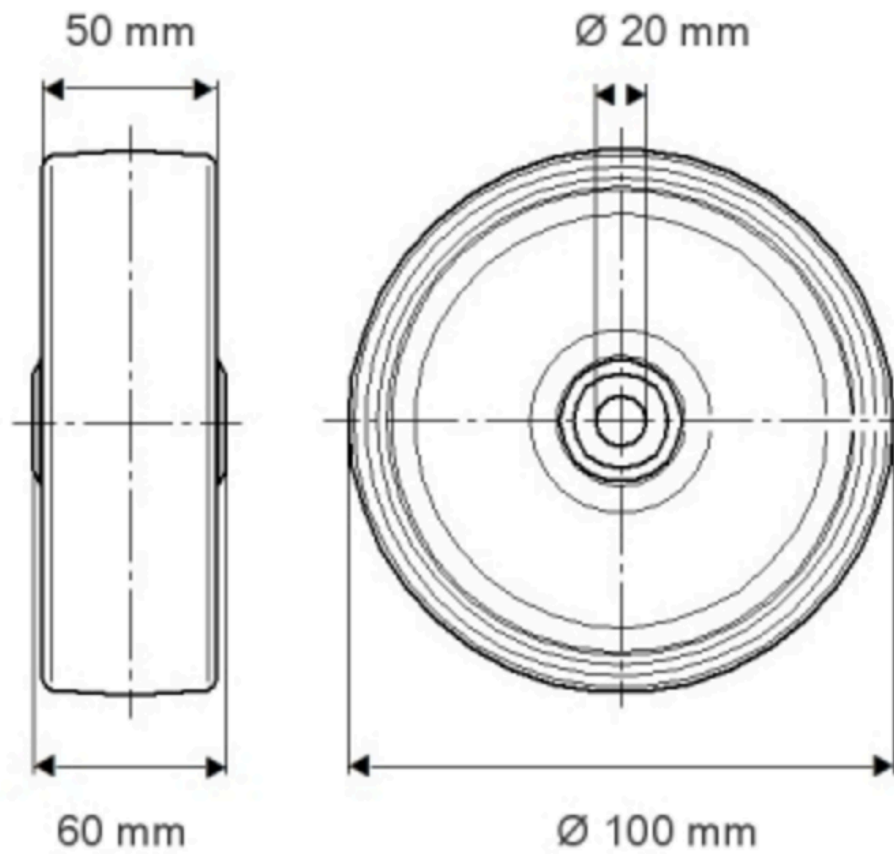

PRODUCT INFORMATION

DURATECH

MOP 100x50-Ø20

EAN 4031582320008

Order number 00801258

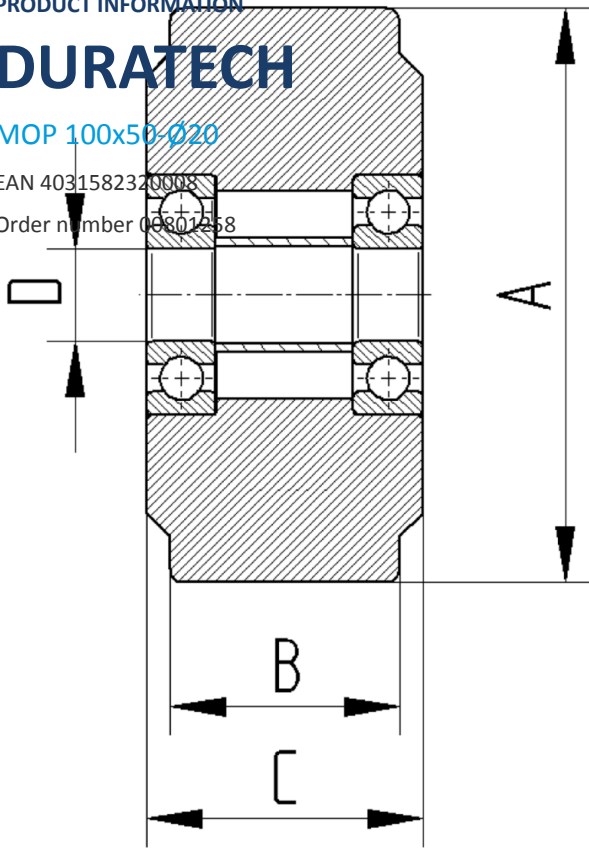

BETTER MOBILITY. BETTER LIFE.