

LEVINA

5371PIP100R05-28X45

EAN 4031582362886



BETTER MOBILITY. BETTER LIFE.



Image may differ from the original product

PERFORMANCE

Roll performance	●●●○○
Movement noise	●●●●●
Attrition	●●●○○
Corrosion resistance	●●●●●

CORE ATTRIBUTES

Product name	Levina
Type	Swivel castor with directional lock
Standard	EN12530 - Devices Castors
Load capacity at 1.8 mph	176.37 lb
Load capacity Static	352.74 lb
Temperature range (Minimum)	14 °F
Temperature range (Maximum)	104 °F
Overall height	5.39 in

WHEEL

Body material	Polypropylene
	soft
Tread material	Solid rubber, non-marking
Bearing	Precision ball bearing
Threadguards	With threadguard
Diameter	3.94 in
Tread width	1.26 in
Hardness of tread (A)	75 Shore A

HOUSING

Material	Polyamide
Fork shape	Slim
Swivel bearing	Two ball races
Offset	1.42 in
Swivel radius	3.86 in
Swivel interference	7.72 in

FITTING

Fitting type	Solid stem, round
Bolt diameter	1.1 in
Bolt length	1.77 in



Universal Design Award



Deutscher Designer Club

LEVINA

5371PIP100R05-28X45

EAN 4031582362886



BETTER MOBILITY. BETTER LIFE.

TECHNICAL DRAWINGS

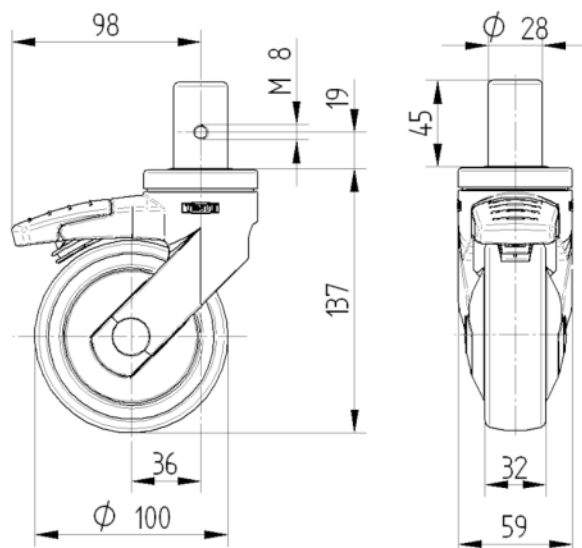

Universal
Design
Award



Deutscher
Designer
Club