

LINEA LOAD

5940UAP050L51-8 load 7001

EAN 4031582431087



BETTER MOBILITY. BETTER LIFE.



Image may differ from the original product

PERFORMANCE

Roll Performance	● ● ● ● ●
Movement noise	● ● ● ● ○
Attrition	● ● ● ● ●
Corrosion resistance	● ● ● ● ○

CORE ATTRIBUTES

Product name	Linea load
Type	Swivel caster
Standard	EN12530 - Devices Castors
Load capacity at 1.8 mph	220.46 lb
Electric conductive	no
Stainless	no
Load capacity Static	440.92 lb
Temperature range (Minimum)	14 °F
Temperature range (Maximum)	104 °F
Overall height	1.99 in
Overall width	1.87 in
Overall weight	0.19 lb

HOUSING

Housing Material	Polyamide
Fork shape	Twin wheel housing
Swivel bearing	Precision ball bearing
Housing Color	Silver gray (RAL7001)
Swivel radius	1.59 in
Swivel interference	3.19 in
Dome diameter	0.91 in

WHEEL

Body material	Polyamide
Tread material	Polyurethane, injected
Bearing	Precision ball bearing
Threadguards	With threadguard
Diameter	1.97 in
Tread width	0.51 in
Hardness of tread (A)	92 Shore A

FITTING

Fitting type	Blind hole for B10 fitting
Bolt hole diameter	0.31 in



Deutscher Designer Club



Interzum Award



IF Design Award

product design award

LINEA LOAD

5940UAP050L51-8 load 7001

EAN 4031582431087



BETTER MOBILITY. BETTER LIFE.

Product Drawings

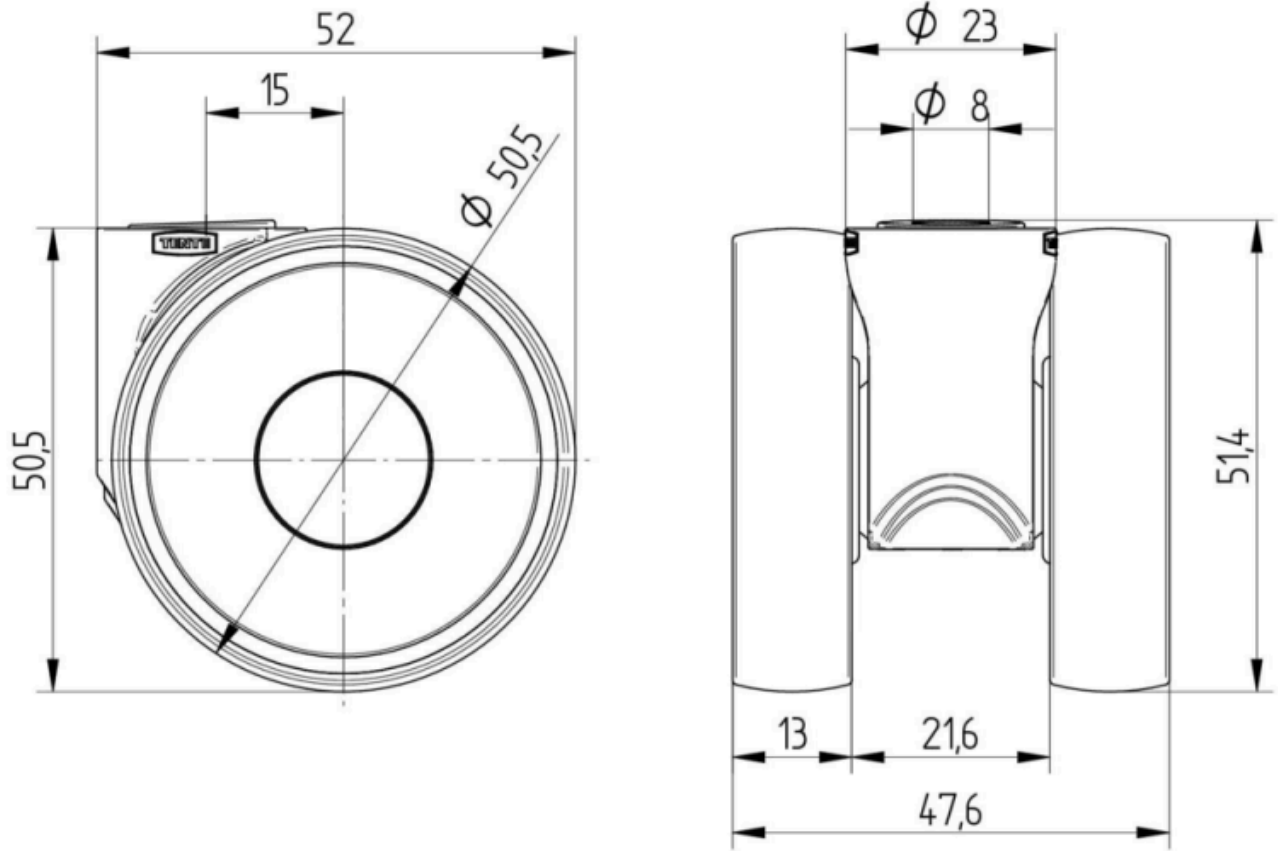

Deutscher Designer Club



Interzum Award



IF Design Award

product design award