

NOVATECH

FTP 250x60-Ø25 HL62

EAN 4031582331066



BETTER MOBILITY. BETTER LIFE.



Image may differ from the original product

WHEEL

Body material	Cast iron
Tread Material Mix	Polyurethane, casted
Bearing	Precision ball bearing
Wheel Color	Honey yellow (RAL1005)
Threadguards	With threadguard
Diameter	250 mm
Tread width	60 mm
Axle Hole Diameter	25 mm
Hub Length	62 mm
Body width	60 mm
Hardness of tread (A)	92 Shore A
Hardness of tread (D)	42 Shore D

PERFORMANCE

Roll Performance	●●●●○
Movement Noise	●●●○○
Attrition	●●●●○
Corrosion Resistance	●●●○○

CORE ATTRIBUTES

Product Name	Novatech
Type	Wheel
Standard	EN12533 - Heavy Duty Castors
Load capacity at 4 km/h	1680 kg
Load capacity at 6 km/h	1400 kg
Electric Conductive	No
Stainless	No
Load capacity Static	2800 kg
Temperature range (Minimum)	-10 °C
Temperature range (Maximum)	60 °C
Overall weight	7.12 kg

NOVATECH

FTP 250x60-Ø25 HL62

EAN 4031582331066

Order number 00803985
Product Drawings



BETTER MOBILITY. BETTER LIFE.

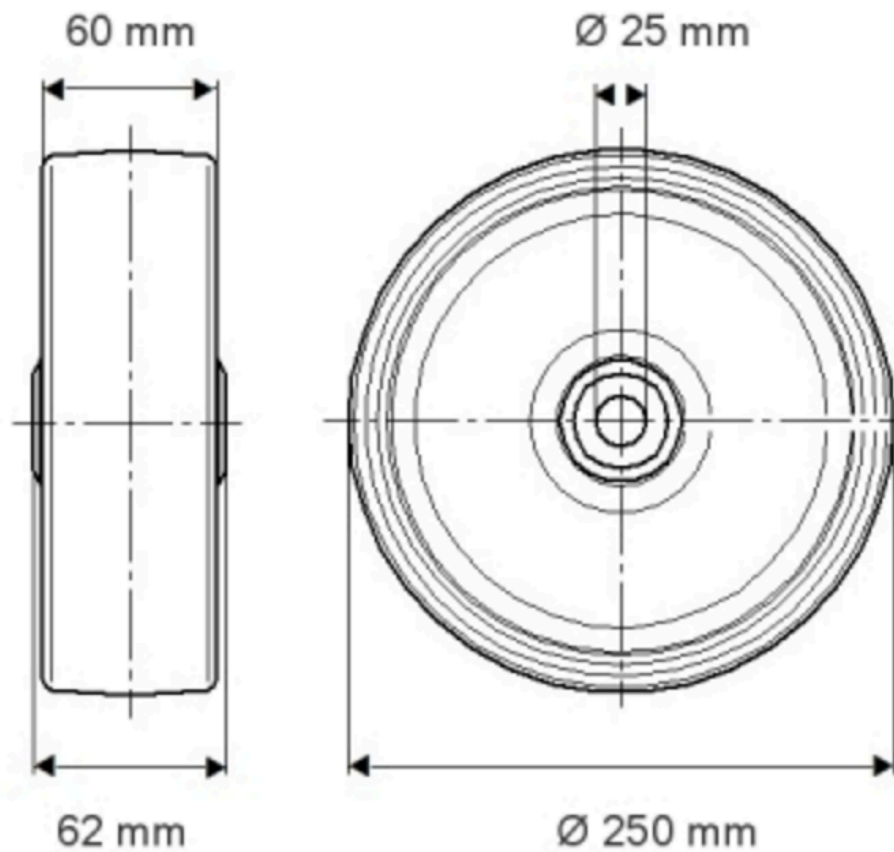

PRODUCT INFORMATION

NOVATECH

FTP 250x60-025 H162

EAN 4031582381066

Order number 00803985

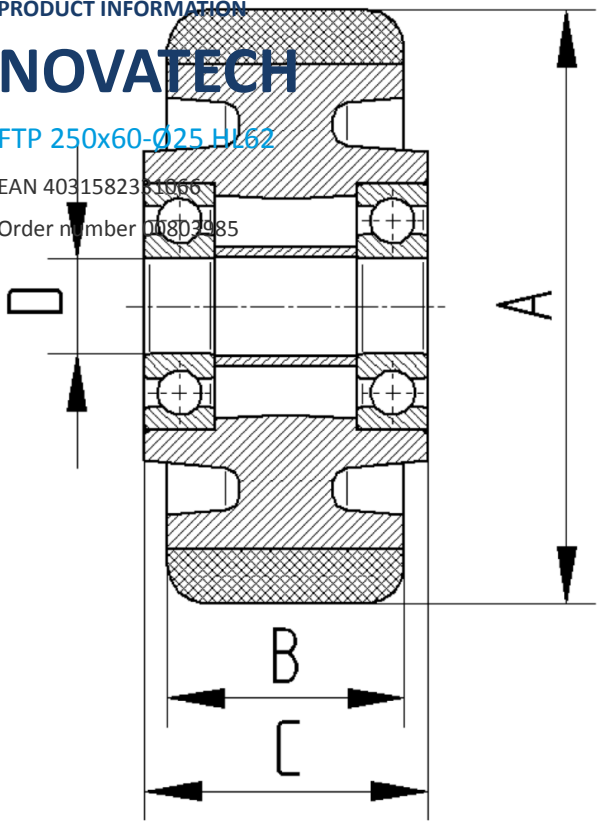

BETTER MOBILITY. BETTER LIFE.