

NOVATECH

ITP160x50-Ø20 HL60 super convex R25

EAN 4031582444667



BETTER MOBILITY. BETTER LIFE.



Image may differ from the original product

WHEEL

Tread profile	convex
Body material	Aluminum
Tread material	Polyurethane, casted
Bearing	Precision ball bearing
Threadguards	Without threadguard
Diameter	6.3 in
Tread width	1.97 in
Axle hole diameter	0.79 in
Hub length	2.36 in
Hardness of tread (A)	92 Shore A

PERFORMANCE

Roll Performance	● ● ● ● ○ ○
Movement noise	● ● ● ● ○ ○
Attrition	● ● ● ● ● ○
Corrosion resistance	● ● ● ● ○ ○

CORE ATTRIBUTES

Product name	Novatech
Type	Wheel
Standard	EN12532 - Transport Equipment
Load capacity at 2.5 mph	1102.31 lb
Electric conductive	no
Stainless	no
Load capacity Static	2204.62 lb
Temperature range (Minimum)	-4 °F
Temperature range (Maximum)	140 °F
Overall weight	2.2 lb

NOVATECH

ITP160x50-Ø20 HL60 super convex R25

EAN 4031582444667



BETTER MOBILITY. BETTER LIFE.

Product Drawings

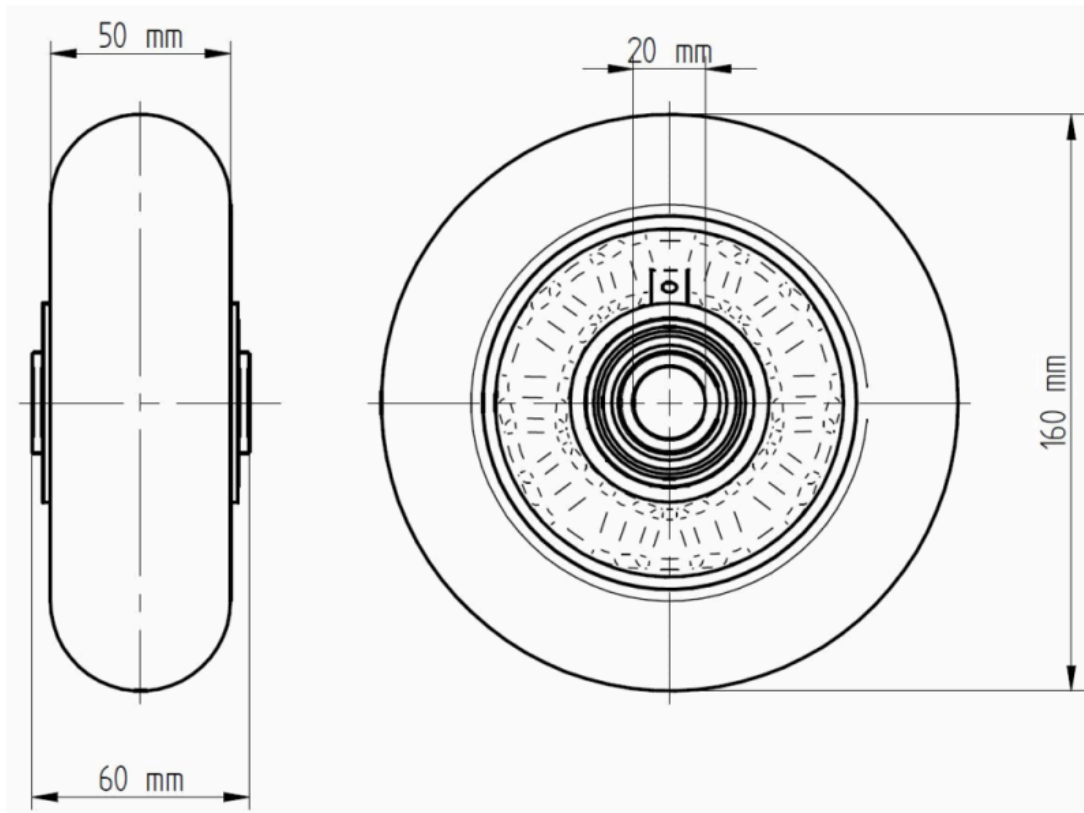

PRODUCT INFORMATION

NOVATECH

ITP160x50-Q20 HL60 super convex R25

EAN 403158244156

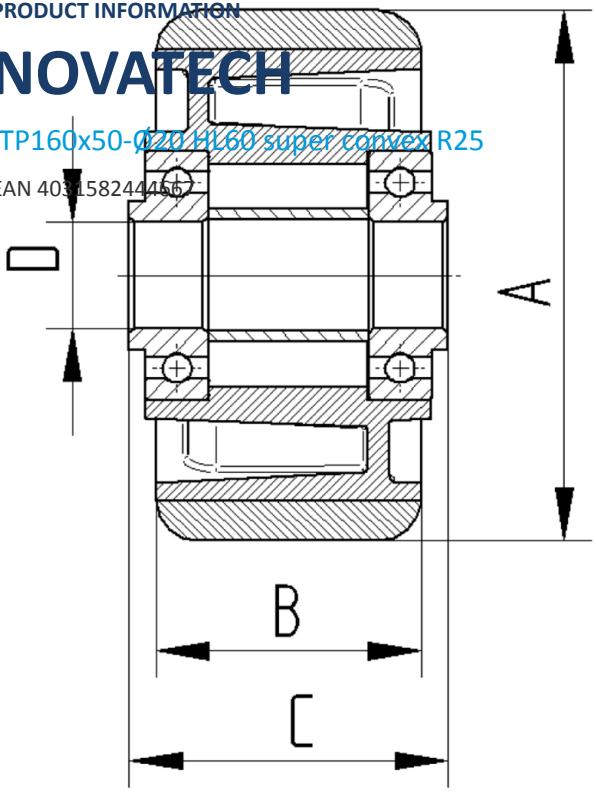

BETTER MOBILITY. BETTER LIFE.