

# ALPHA

3470BOG080P62

EAN 4031582345698



BETTER MOBILITY. BETTER LIFE.



Image may differ from the original product

## PERFORMANCE

Roll performance	● ● ● ● ○
Movement noise	● ● ● ○ ○
Attrition	● ● ● ● ●
Corrosion resistance	● ● ● ● ●

## CORE ATTRIBUTES

Product name	Alpha
Type	Swivel castor
Standard	EN12532 - Transport Equipment
Load capacity at 2.5 mph	220.46 lb
Load capacity Static	440.92 lb
Temperature range (Minimum)	-40 °F
Temperature range (Maximum)	536 °F
Overall height	4.25 in
Overall weight	1.5 lb

## WHEEL

Body material	Plastic thermoset, heat-resistant
Tread material	Identical with wheel body
Bearing	Dry bearing bush
Axle	Screwed with nut
Diameter	3.15 in
Tread width	1.38 in
Hardness of tread (D)	85 Shore D

## HOUSING

Material	Steel sheet, heavy
Fork shape	Broad
Swivel bearing	Two ball races
Offset	1.57 in
Swivel radius	3.15 in
Swivel interference	6.3 in

## FITTING

Fitting type	Rectangular plate
Plate length	4.13 in
Plate width	3.15 in
Plate hole length (Minimum)	3.03 in
Plate hole length (Maximum)	3.15 in
Plate hole width (Maximum)	2.36 in
Plate hole diameter	0.35 in

# ALPHA

3470BOG080P62

EAN 4031582345698



BETTER MOBILITY. BETTER LIFE.

## TECHNICAL DRAWINGS

3470U00080P62-neu

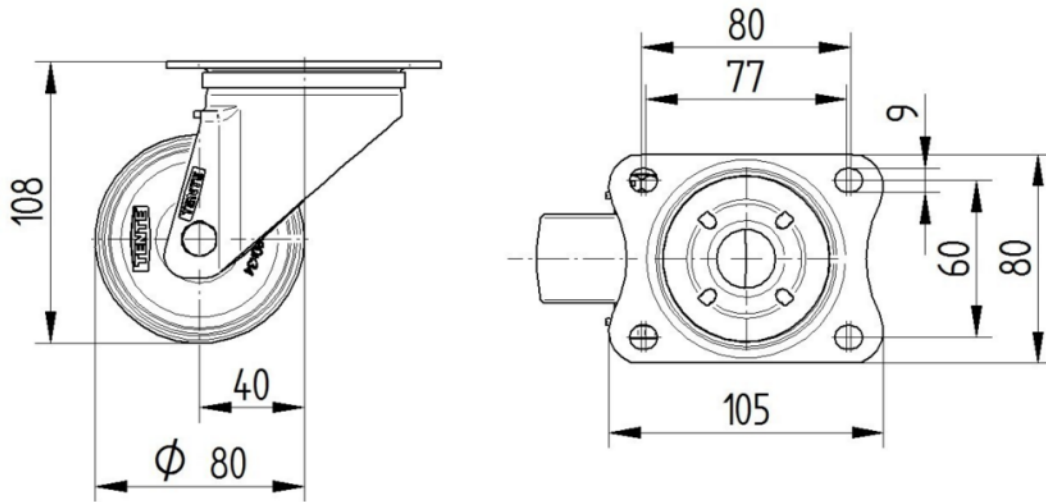

Platte 3470-080P62-105x80

