

NOVATECH

FTP200x80-Ø25 HL90

EAN 4031582329681



BETTER MOBILITY. BETTER LIFE.



Image may differ from the original product

WHEEL

Body material	Cast iron
Tread Material Mix	Polyurethane, casted
Bearing	Precision ball bearing
Threadguards	With threadguard
Diameter	200 mm
Tread width	80 mm
Axle Hole Diameter	25 mm
Hub Length	90 mm
Hardness of tread (A)	92 Shore A

PERFORMANCE

Roll Performance	● ● ● ● ● ○
Movement Noise	● ● ● ● ○ ○
Attrition	● ● ● ● ● ○
Corrosion Resistance	● ● ● ● ○ ○

CORE ATTRIBUTES

Product Name	Novatech
Type	Wheel
Standard	EN12533 - Heavy Duty Castors
Load capacity at 4 km/h	1680 kg
Load capacity at 6 km/h	1400 kg
Electric Conductive	No
Stainless	No
Load capacity Static	3360 kg
Temperature range (Minimum)	-20 °C
Temperature range (Maximum)	60 °C
Overall weight	7.06 kg

NOVATECH

FTP200x80-Ø25 HL90

EAN 4031582329681



BETTER MOBILITY. BETTER LIFE.

Product Drawings

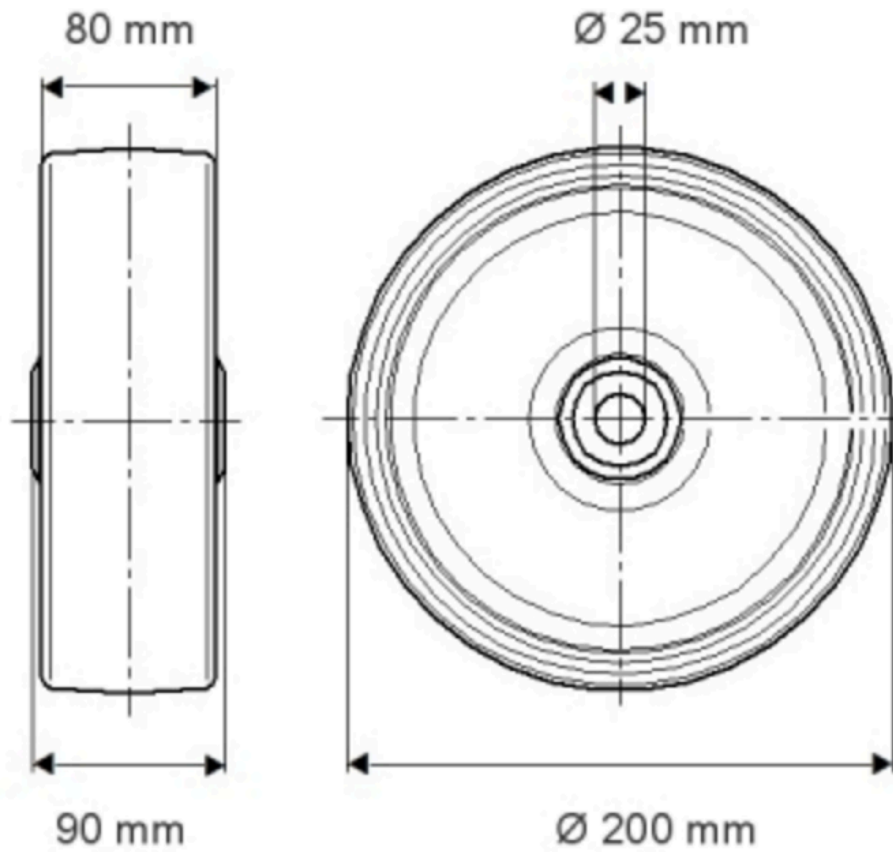

PRODUCT INFORMATION

NOVATECH

FTP200x80-Ø25 HI 90

EAN 4031582329681

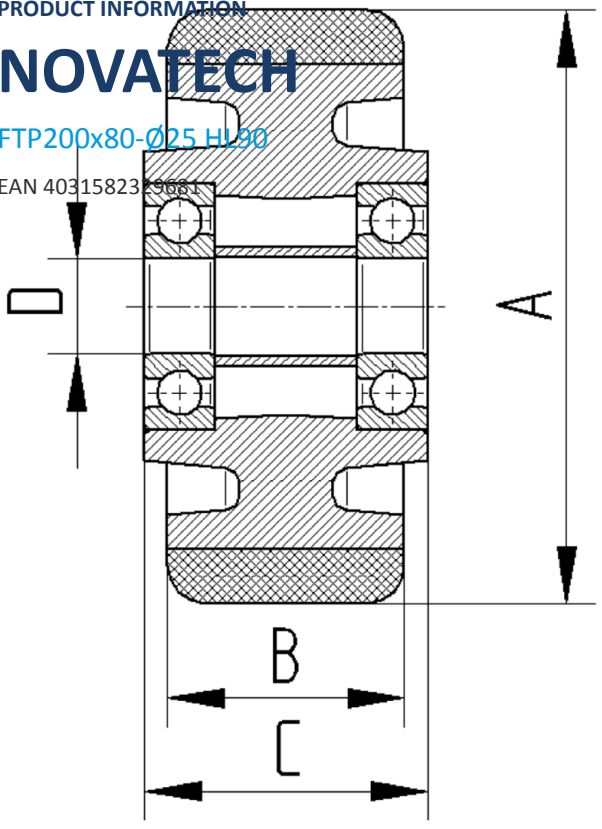

BETTER MOBILITY. BETTER LIFE.