

# DURATECH

MOP 200x50-Ø35 HL60

EAN 4031582320053



BETTER MOBILITY. BETTER LIFE.



Image may differ from the original product

## WHEEL

Body material	Polyamide, super heavy
Tread Material Mix	Identical with wheel body
Bearing	Precision ball bearing
Wheel Color	Natural white
Threadguards	Without threadguard
Diameter	200 mm
Tread width	50 mm
Axle Hole Diameter	35 mm
Hub Length	60 mm
Body width	50 mm
Hardness of tread (D)	75 Shore D
Bearing type	6307

## PERFORMANCE

Roll Performance	● ● ● ● ●
Movement Noise	● ● ○ ○ ○
Attrition	● ● ● ● ●
Corrosion Resistance	● ● ● ○ ○

## CORE ATTRIBUTES

Product Name	Duratech
Type	Wheel
Standard	EN12533 - Heavy Duty Castors
Load capacity at 4 km/h	3360 kg
Load capacity at 6 km/h	2800 kg
Electric Conductive	No
Stainless	No
Load capacity Static	5600 kg
Temperature range (Minimum)	-40 °C
Temperature range (Maximum)	80 °C
Overall weight	2.58 kg

# DURATECH

MOP 200x50-Ø35 HL60

EAN 4031582320053

Order number 00801262  
Product Drawings



BETTER MOBILITY. BETTER LIFE.

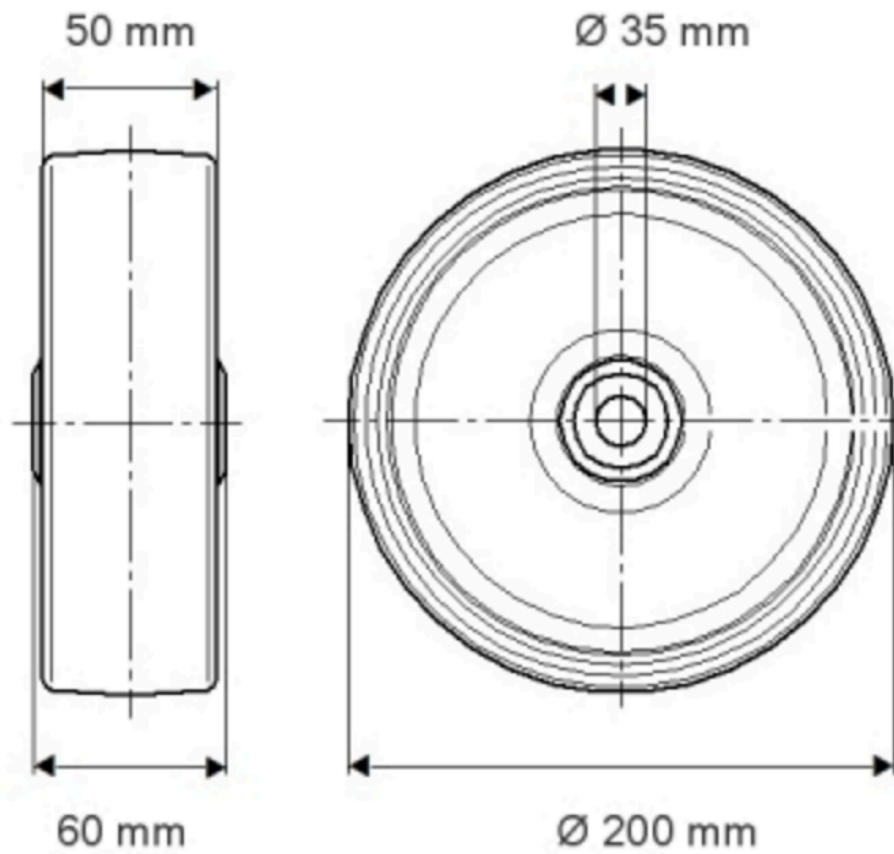

PRODUCT INFORMATION

# DURATECH

MOP 200x50-Ø35 HL60

EAN 4031582320053

Order number 00801252

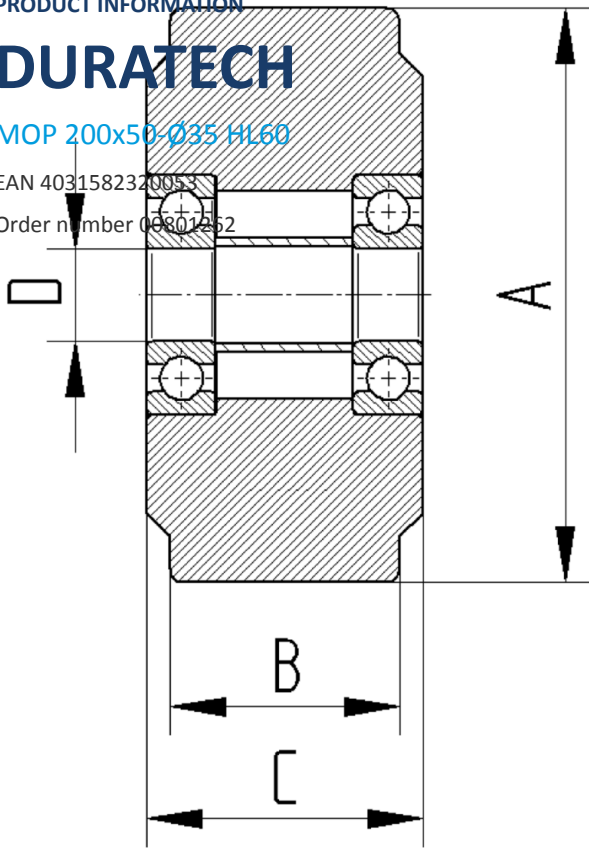

BETTER MOBILITY. BETTER LIFE.