

DURATECH

MOP 150x80-Ø35 HL90

EAN 4031582320039



BETTER MOBILITY. BETTER LIFE.



Slika se može razlikovati od originalnog proizvoda

TOCAK

Materijal za telo	poliamid, super težak
materijal omotaca	Identično sa telom Tocak
Nošenje	precizini kuglicni lezaj
Boja Tocak	Prirodno belo
štيتnici omotaca	Bez stražara
Prečnik	150 mm
Širina omotac	80 mm
dimenzija rupa osovina	35 mm
dužina glavnice	90 mm
Širina tela	80 mm
Teškoća gazećeg omotac (D)	75 Šor D
Tip ležaja	6207

PERFORMANSE

Performanse kotrljanja	● ● ● ● ●
Buka u pokretu	● ● ○ ○ ○
Ishrana	● ● ● ● ●
otpornost na rdju	● ● ● ○ ○

OSNOVNI ATRIBUTI

Naziv proizvoda	Duratech
Tip	Tocak
Standard	EN12533 - Tockovi za teske terete
Nosivost na 4 km/h	3600 kg
Nosivost na 6 km/h	3000 kg
Električni provod	no
nerdjajuci	no
Statički Nosivost	6000 kg
Temperaturni opseg (Minimalno)	-40 °C
Opseg temperature (maksimalni)	80 °C
Ukupna težina	2.03 kg

DURATECH

MOP 150x80-Ø35 HL90

EAN 4031582320039

Broj porudžbine 00830848
Product Drawings



BETTER MOBILITY. BETTER LIFE.

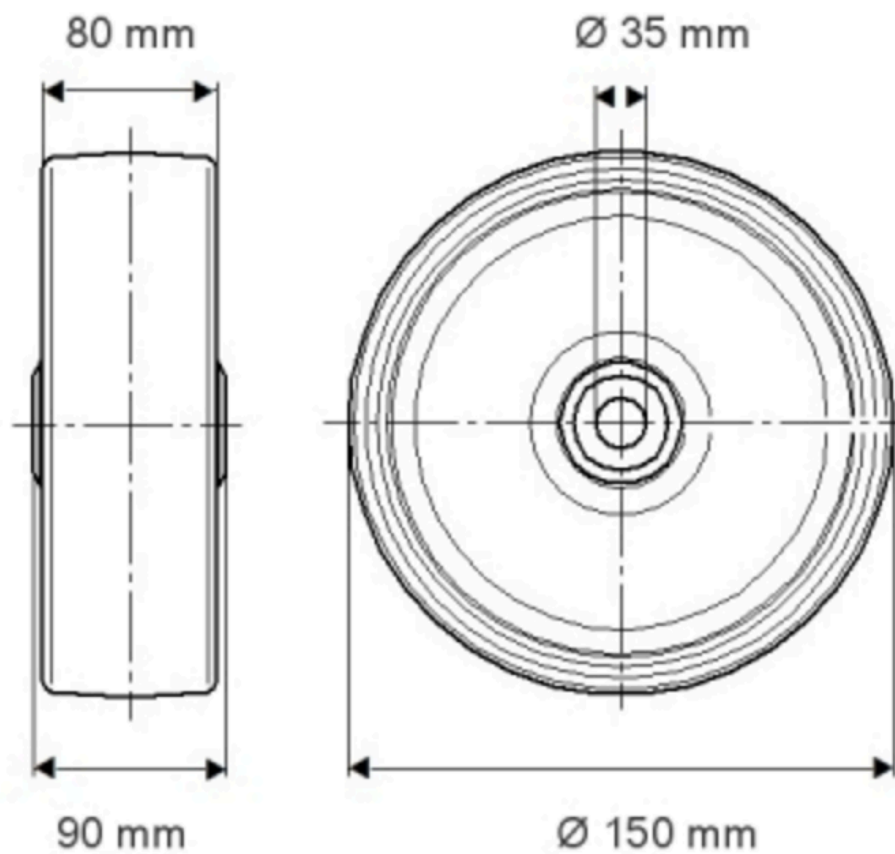

INFORMACIJE O PROIZVODU

DURATECH

MOP 150x80-Ø35 HL90

EAN 4031582320039

Broj porudžbine 00836848

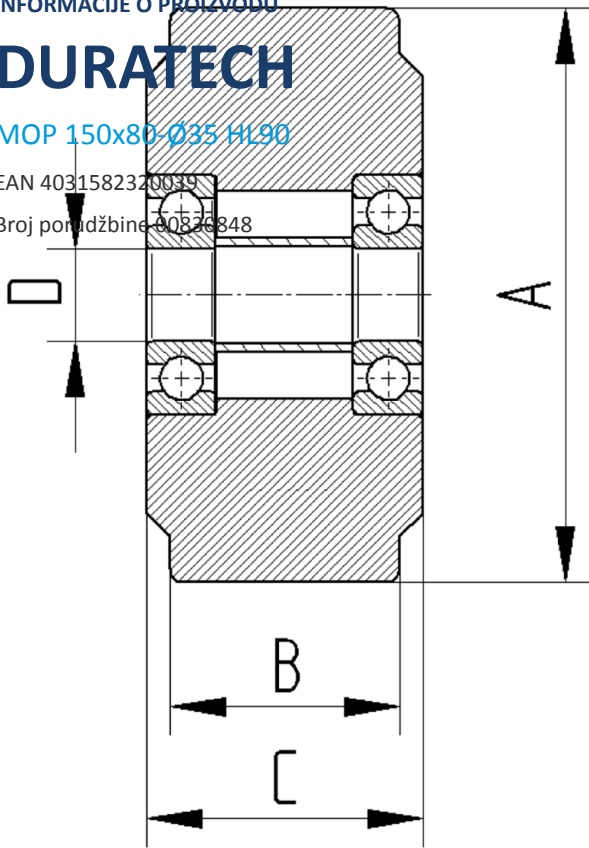

BETTER MOBILITY. BETTER LIFE.