

LINEA CLINIC

5944UAC150R36-32S30OH155 4XM6

EAN 4031582359916



BETTER MOBILITY. BETTER LIFE.



Image may differ from the original product

PERFORMANCE

Roll performance	● ● ● ● ●
Movement noise	● ● ● ○ ○
Attrition	● ● ● ● ○
Corrosion resistance	● ● ● ● ○

CORE ATTRIBUTES

Product name	Linea clinic
Type	Swivel castor with central, total or directional lock
Standard	similar EN12531- Hospital Bed Castors
Load capacity at 3 km/h	150 kg
Load capacity at 4 km/h	150 kg
Stainless	✓
Load capacity Static	300 kg
Temperature range (Minimum)	-10 °C
Temperature range (Maximum)	40 °C
Overall height	155 mm
Overall width	71 mm
Overall weight	1.16 kg

Certification Tested and monitored by TÜV Süd



Deutscher Designer Club



Interzum Award



IF Design Award

WHEEL

Body material	Polyamide
Tread material	Polyurethane, injected
Bearing	Precision ball bearing, stainless
Threadguards	With threadguard
Diameter	150 mm
Tread width	15 mm
Hardness of tread (A)	92 Shore A

HOUSING

Material fork	Polyamide
Fork shape	Twin wheel housing
Swivel bearing	Precision ball bearing
Offset	47.5 mm
Swivel radius	122.5 mm
Swivel interference	254 mm

FITTING

Brake cam	hex cam
Fitting type	Stem with cam hole for profile bars, short version
Bolt diameter	32 mm
Bolt length	50 mm
Hint	Washable beds must be sealed in the fitting area by the hospital bed manufacturer.

LINEA CLINIC

5944UAC150R36-32S300H155 4XM6

EAN 4031582359916



BETTER MOBILITY. BETTER LIFE.

TECHNICAL DRAWINGS

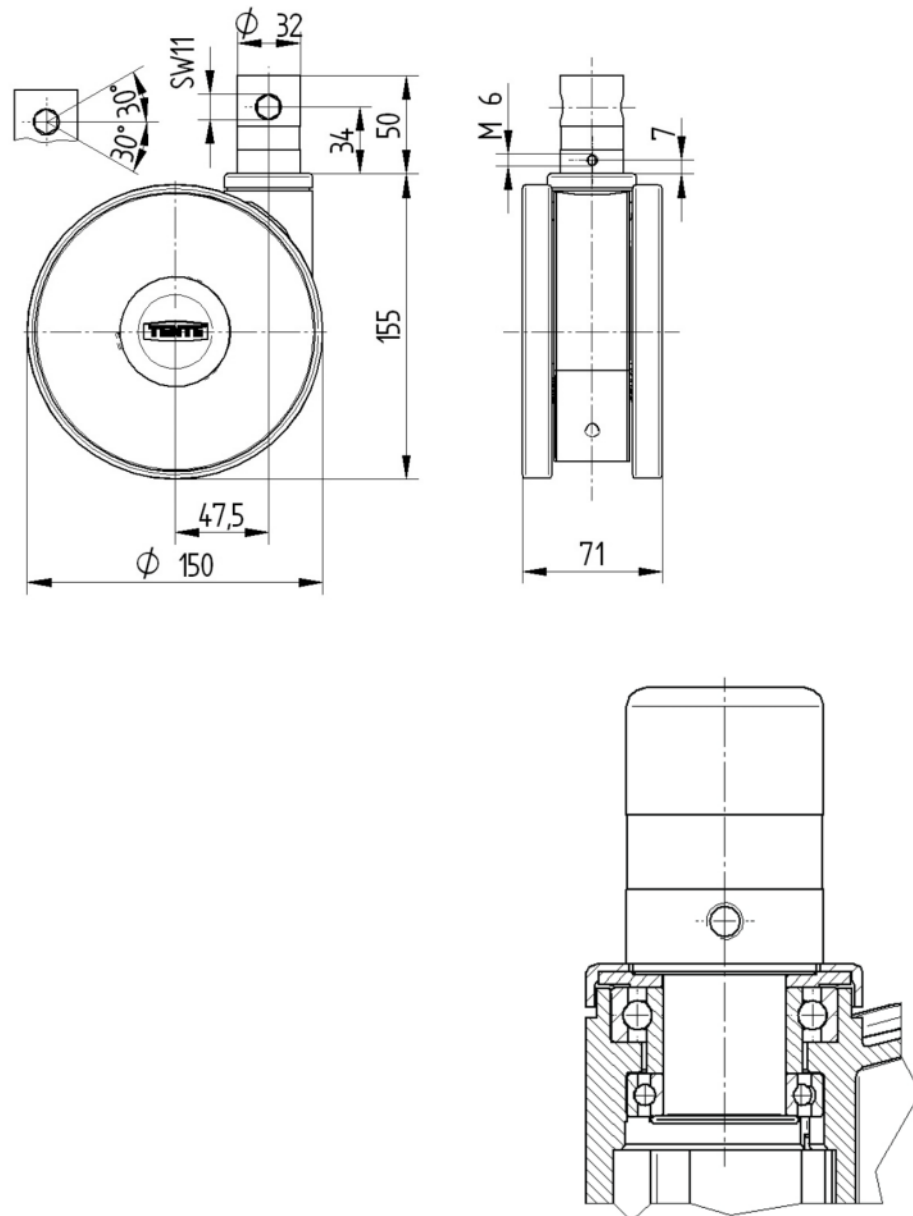

Deutscher
Designer
Club



Interzum
Award



IF
Design
Award