

NOVATECH

FTP 200x60-Ø25 HL60

EAN 4031582329674



BETTER MOBILITY. BETTER LIFE.



Image may differ from the original product

WHEEL

| | |
|-----------------------|------------------------|
| Body material | Cast iron |
| Tread Material Mix | Polyurethane, casted |
| Bearing | Precision ball bearing |
| Wheel Color | Honey yellow (RAL1005) |
| Threadguards | With threadguard |
| Diameter | 200 mm |
| Tread width | 60 mm |
| Axle Hole Diameter | 25 mm |
| Hub Length | 60 mm |
| Body width | 60 mm |
| Hardness of tread (A) | 92 Shore A |
| Hardness of tread (D) | 42 Shore D |

PERFORMANCE

| | |
|----------------------|-------|
| Roll Performance | ●●●●○ |
| Movement Noise | ●●●○○ |
| Attrition | ●●●●○ |
| Corrosion Resistance | ●●●○○ |

CORE ATTRIBUTES

| | |
|-----------------------------|------------------------------|
| Product Name | Novatech |
| Type | Wheel |
| Standard | EN12533 - Heavy Duty Castors |
| Load capacity at 4 km/h | 1440 kg |
| Load capacity at 6 km/h | 1200 kg |
| Electric Conductive | No |
| Stainless | No |
| Load capacity Static | 2400 kg |
| Temperature range (Minimum) | -10 °C |
| Temperature range (Maximum) | 60 °C |
| Overall weight | 5.35 kg |

NOVATECH

FTP 200x60-Ø25 HL60

EAN 4031582329674

Order number 00803012
Product Drawings



BETTER MOBILITY. BETTER LIFE.

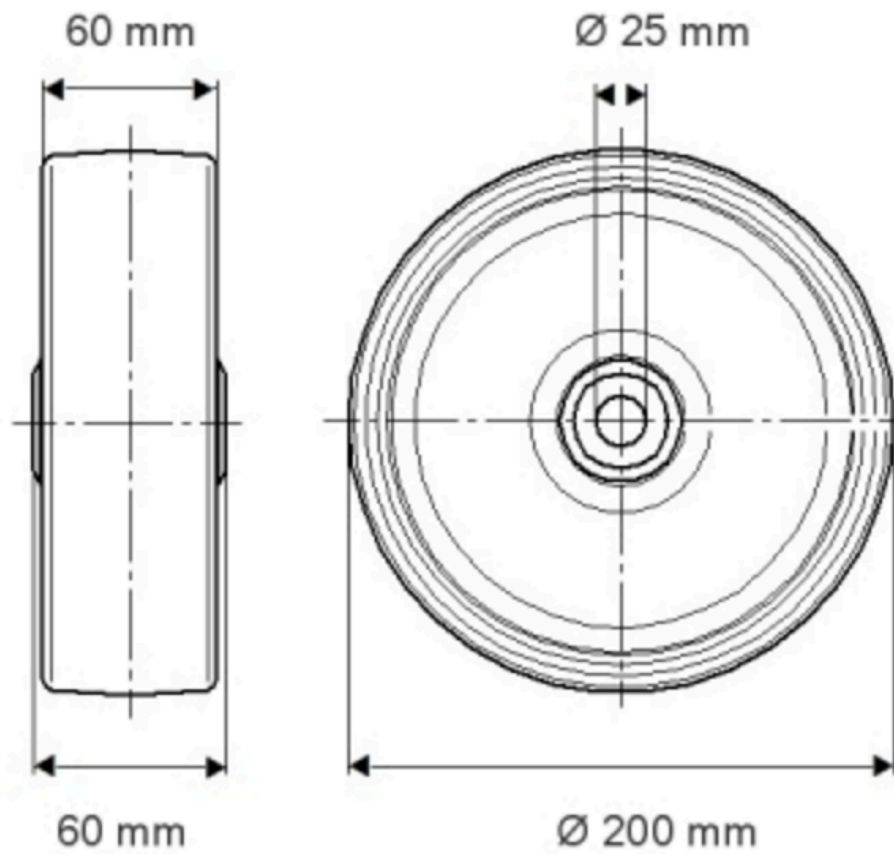

PRODUCT INFORMATION

NOVATECH

FTP 200x60-025 H160

EAN 4031582329674

Order number 00803012

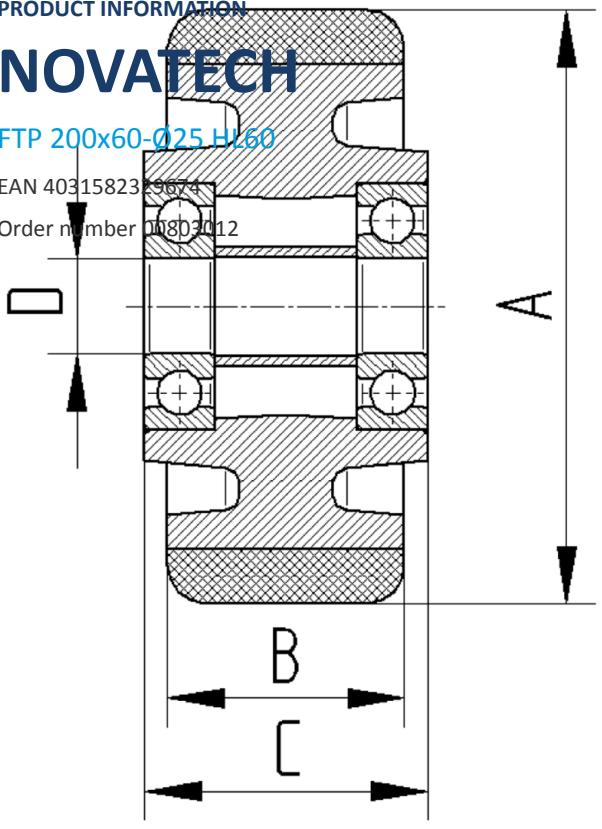

BETTER MOBILITY. BETTER LIFE.