

ULTRATECH

FCP160x50-Ø20

EAN 4031582445152



BETTER MOBILITY. BETTER LIFE.



Image may differ from the original product

WHEEL

Body material	Cast iron
Tread Material Mix	Ultratech Polyurethane, casted
Bearing	Precision ball bearing
Threadguards	With threadguard
Diameter	160 mm
Tread width	50 mm
Axle Hole Diameter	20 mm
Hub Length	60 mm
Hardness of tread (A)	92 Shore A

PERFORMANCE

Roll Performance	● ● ● ● ● ○
Movement Noise	● ● ● ● ○ ○
Attrition	● ● ● ● ● ○
Corrosion Resistance	● ● ● ● ○ ○

CORE ATTRIBUTES

Product Name	Ultratech
Type	Wheel
Standard	EN12532 - Transport Equipment
Load capacity at 4 km/h	800 kg
Load capacity at 6 km/h	640 kg
Electric Conductive	No
Stainless	No
Load capacity Static	1600 kg
Temperature range (Minimum)	-20 °C
Temperature range (Maximum)	60 °C
Overall weight	1.1 kg

ULTRATECH

FCP160x50-Ø20

EAN 4031582445152



BETTER MOBILITY. BETTER LIFE.

Product Drawings



PRODUCT INFORMATION

ULTRATECH

FCP160x50-Ø20

EAN 4031582445115

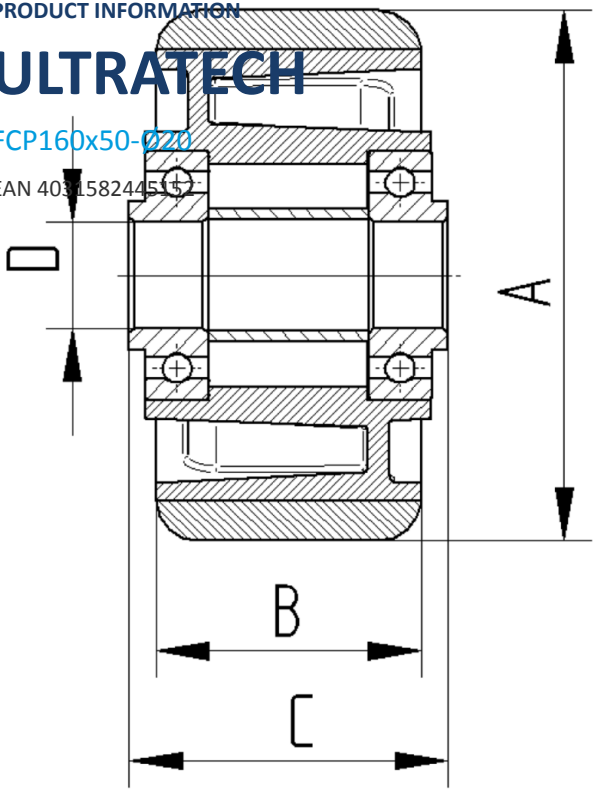

BETTER MOBILITY. BETTER LIFE.