

PRODUCT INFORMATION

PURETECH

FVP 200x75-Ø25 HL90

EAN 4031582365412



BETTER MOBILITY. BETTER LIFE.



Image may differ from the original product

WHEEL

Tread hardness	soft
Body material	Casting
Tread material	Solid rubber, black
Bearing	Precision ball bearing
Wheel color	Jet black (similar RAL9005)
Threadguards	With threadguard
Diameter	7.87 in
Tread width	2.95 in
Axle hole diameter	0.98 in
Hub length	3.54 in
Body width	2.95 in
Hardness of tread (A)	68 Shore A

PERFORMANCE

Roll Performance	● ● ● ○ ○ ○
Movement noise	● ● ● ● ● ●
Attrition	● ● ● ● ○ ○
Corrosion resistance	● ● ● ○ ○ ○

CORE ATTRIBUTES

Product name	Puretech
Type	Wheel
Standard	EN12533 - Heavy Duty Castors
Load capacity at 2.5 mph	1322.77 lb
Load capacity at 3.7 mph	1102.31 lb
Electric conductive	no
Stainless	no
Load capacity Static	2204.62 lb
Temperature range (Minimum)	-4 °F
Temperature range (Maximum)	176 °F
Overall weight	12.99 lb

PURETECH

FVP 200x75-Ø25 HL90

EAN 4031582365412

Order number 00828528
Product Drawings



BETTER MOBILITY. BETTER LIFE.

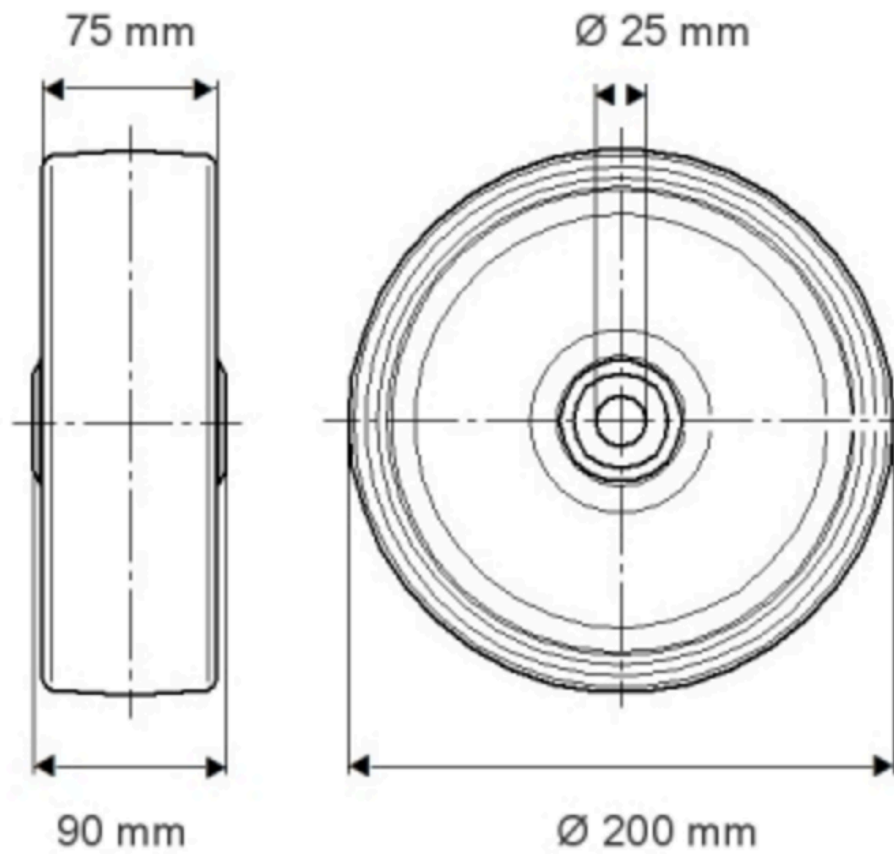

PRODUCT INFORMATION

PURETECH

FVP 200x75-Ø25 H190

EAN 4031582365412

Order number 00829528

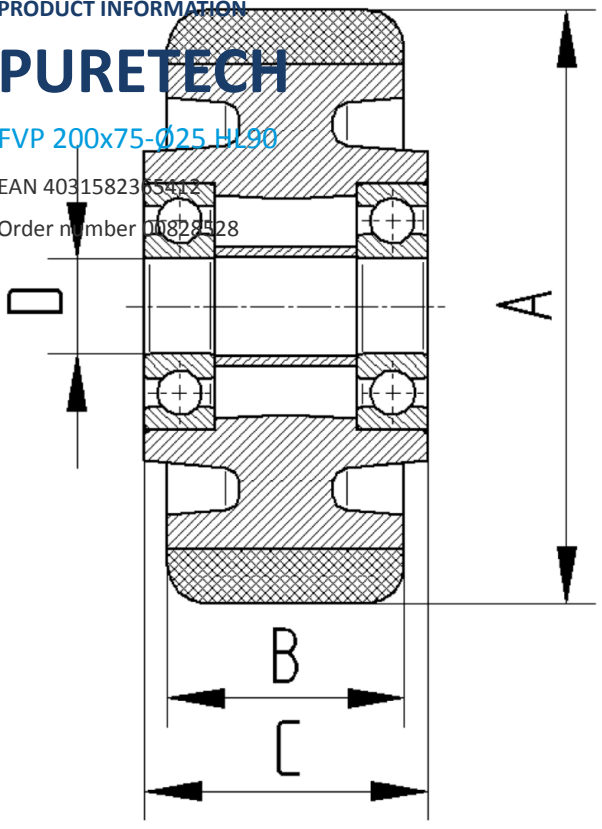

BETTER MOBILITY. BETTER LIFE.