

LINEA

5941UAP125R05-22 RAL9002

EAN 4031582369182



BETTER MOBILITY. BETTER LIFE.



Afbeelding kan afwijken van het oorspronkelijke product

PRESTATIES

Rolprestaties	● ● ● ● ●
Bewegingsgeluid	● ● ● ○ ○
Slijtage	● ● ● ● ○
Corrosiebestendigheid	● ● ● ● ○

KERNKENMERKEN

Productnaam	Linea
Type	Wielen met Richtingslot
Standaard	EN12530 - Hulpmiddelen zwenkwielen
Draagvermogen bij 3 km/h	130 kg
Statisch draagvermogen	260 kg
Temperatuurbereik (minimaal)	-10 °C
Temperatuurbereik (maximaal)	40 °C
Totale hoogte	145 mm
Totale breedte	82 mm
Totaal gewicht	1,07 kg

WIEL

Materiaal wielkern	Polyamide
Materiaal loopvlak	Polyurethaan, Gespoten
Lagering	Precisie kogellagers
Afdekkapjes	Met draadbeschermer
Diameter	125 mm
Breedte Loopvlak	20 mm
Hardheid van het Loopvlak (A)	92 Shore A

BEHUIZING

Materiaal	Polyamide
Vork Vorm	Behuizing met twee Wiel
Zwenklager	Precisie kogellagers
Kleur	Grijs wit (RAL9002)
Offset	40 mm
Zwenk radius	129 mm
Draaicirkel	258 mm
Diameter koepel	52 mm

FITTING

Type bevestiging	Vaste Kraagpen, rond
Diameter Bout	22 mm
Lengte Bout	40 mm



Deutscher
Ontwerper
Club



Interzum
Award



IF
Design
Award

LINEA

5941UAP125R05-22 RAL9002

EAN 4031582369182



BETTER MOBILITY. BETTER LIFE.

TECHNISCHE TEKENINGEN

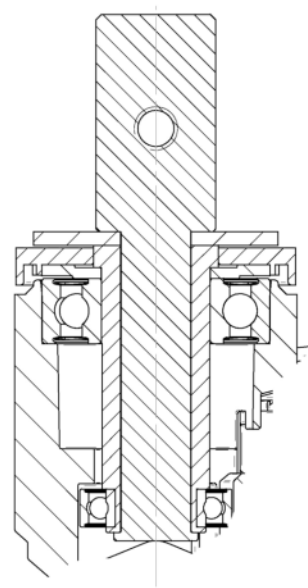

Deutscher
Ontwerper
Club



Interzum
Award



IF
Design
Award