

NOVATECH

FTP 250x80-Ø30 HL90

EAN 4031582319422



BETTER MOBILITY. BETTER LIFE.



Image may differ from the original product

WHEEL

Body material	Cast iron
Tread Material Mix	Polyurethane, casted
Bearing	Precision ball bearing
Wheel Color	Honey yellow (RAL1005)
Threadguards	With threadguard
Diameter	250 mm
Tread width	80 mm
Axle Hole Diameter	30 mm
Hub Length	90 mm
Body width	80 mm
Hardness of tread (A)	92 Shore A
Hardness of tread (D)	42 Shore D

PERFORMANCE

Roll Performance	●●●●○
Movement Noise	●●●○○
Attrition	●●●●○
Corrosion Resistance	●●●○○

CORE ATTRIBUTES

Product Name	Novatech
Type	Wheel
Standard	EN12533 - Heavy Duty Castors
Load capacity at 4 km/h	2160 kg
Load capacity at 6 km/h	1800 kg
Electric Conductive	No
Stainless	No
Load capacity Static	3600 kg
Temperature range (Minimum)	-10 °C
Temperature range (Maximum)	60 °C
Overall weight	9.24 kg

NOVATECH

FTP 250x80-Ø30 HL90

EAN 4031582319422

Order number 00801280
Product Drawings



BETTER MOBILITY. BETTER LIFE.

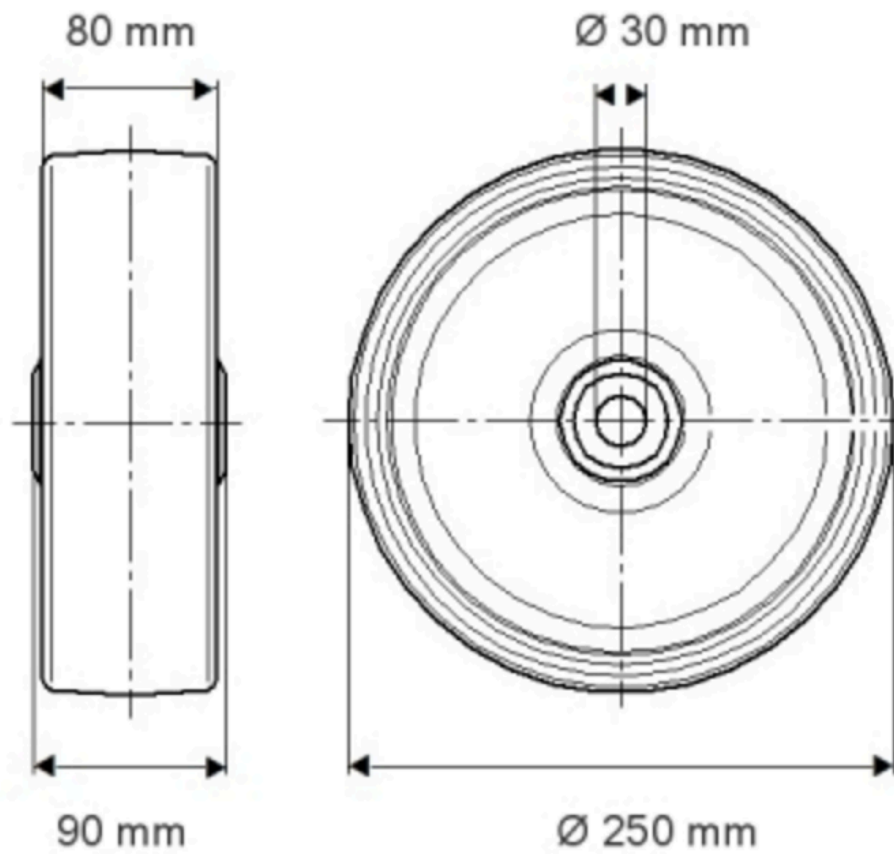

PRODUCT INFORMATION

NOVATECH

FTP 250x80-030 H190

EAN 4031582319472

Order number 00801280

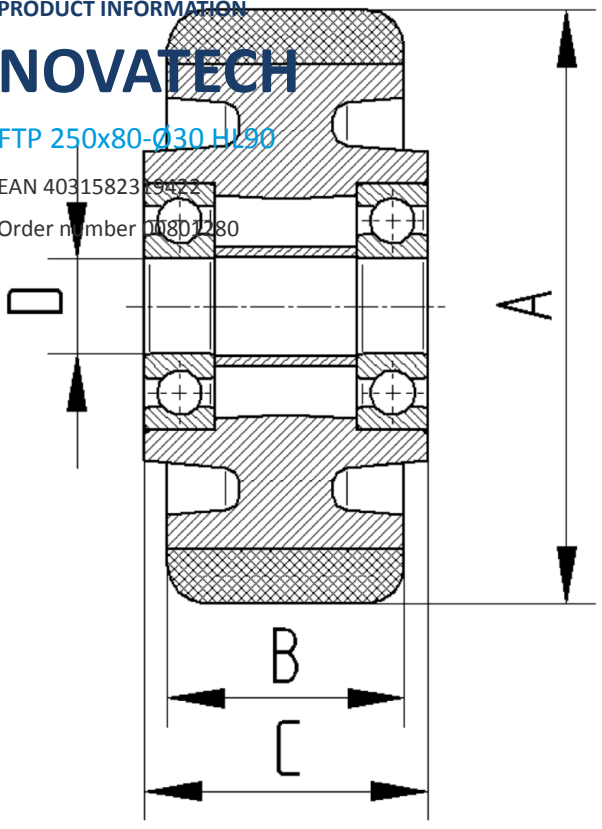

BETTER MOBILITY. BETTER LIFE.