

DURATECH

MOP 150x80-Ø35 HL90

EAN 4031582320039



BETTER MOBILITY. BETTER LIFE.



Image may differ from the original product

WHEEL

Body material	Polyamide, super heavy
Tread Material Mix	Identical with wheel body
Bearing	Precision ball bearing
Wheel Color	Natural white
Threadguards	Without threadguard
Diameter	150 mm
Tread width	80 mm
Axle Hole Diameter	35 mm
Hub Length	90 mm
Body width	80 mm
Hardness of tread (D)	75 Shore D
Bearing type	6207

PERFORMANCE

Roll Performance	● ● ● ● ●
Movement Noise	● ● ○ ○ ○
Attrition	● ● ● ● ●
Corrosion Resistance	● ● ● ○ ○

CORE ATTRIBUTES

Product Name	Duratech
Type	Wheel
Standard	EN12533 - Heavy Duty Castors
Load capacity at 4 km/h	3600 kg
Load capacity at 6 km/h	3000 kg
Electric Conductive	No
Stainless	No
Load capacity Static	6000 kg
Temperature range (Minimum)	-40 °C
Temperature range (Maximum)	80 °C
Overall weight	2.03 kg

DURATECH

MOP 150x80-Ø35 HL90

EAN 4031582320039

Order number 00830848
Product Drawings



BETTER MOBILITY. BETTER LIFE.

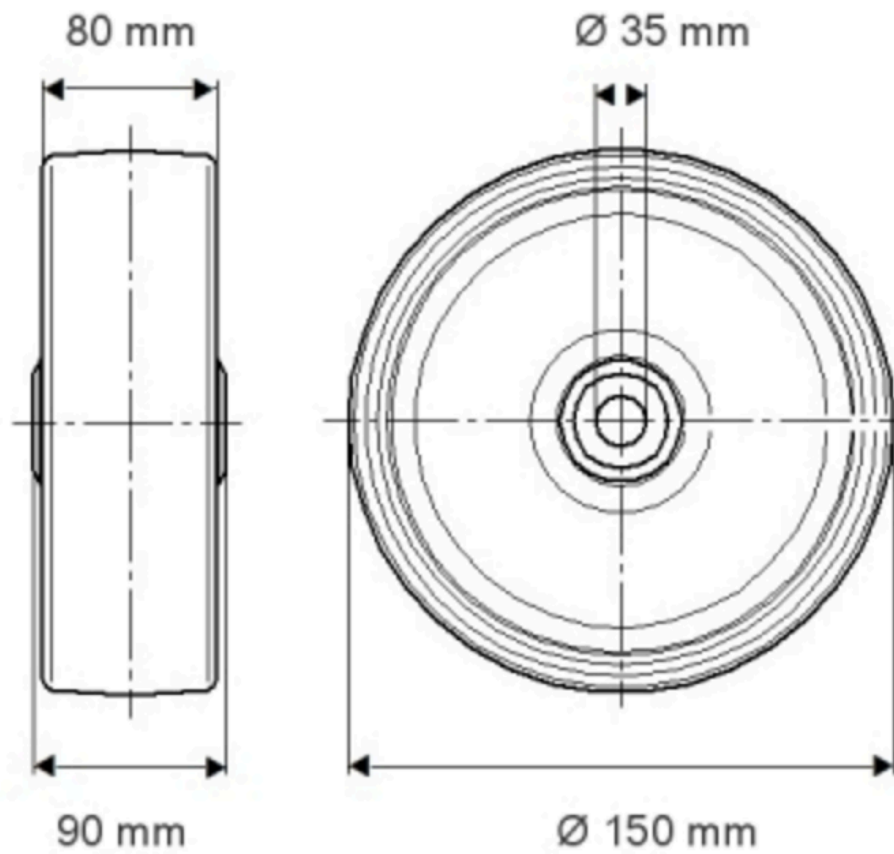

PRODUCT INFORMATION

DURATECH

MOP 150x80-Ø35 HL90

EAN 4031582320039

Order number 00830548

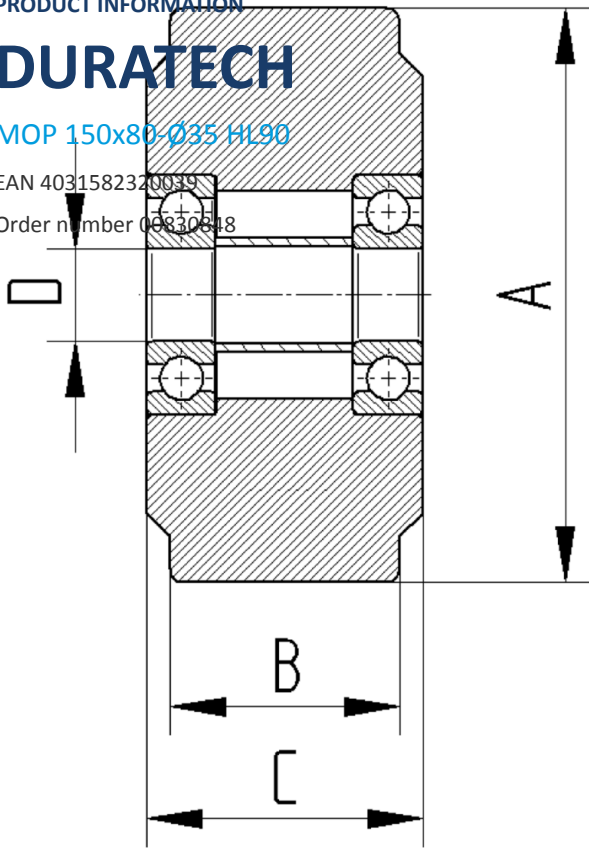

BETTER MOBILITY. BETTER LIFE.