

LINEA

5940UAC100P51 RAL9002

EAN 4031582352924



BETTER MOBILITY. BETTER LIFE.



Afbeelding kan afwijken van het oorspronkelijke product

PRESTATIES

Rolprestaties	● ● ● ● ●
Bewegingsgeluid	● ● ● ○ ○
Slijtage	● ● ● ● ○
Corrosiebestendigheid	● ● ● ● ○

KERNKENMERKEN

Productnaam	Linea
Type	Wielen
Standaard	EN12530 - Hulpmiddelen zwenkwielen
Draagvermogen bij 3 km/h	120 kg
Roestvrij	✓
Statisch draagvermogen	240 kg
Temperatuurbereik (minimaal)	-10 °C
Temperatuurbereik (maximaal)	40 °C
Totale hoogte	124 mm
Totale breedte	82 mm

WIEL

Materiaal wielkern	Polyamide
Materiaal loopvlak	Polyurethaan, Gespoten
Lagering	Precisie kogellagers Roestvrij
Afdekkapjes	Met draadbeschermer
Diameter	100 mm
Breedte Loopvlak	20 mm
Hardheid van het Loopvlak (A)	92 Shore A

BEHUIZING

Materiaal	Polyamide
Vork Vorm	Behuizing met twee Wiel
Zwenklager	Precisie kogellagers
Kleur	Grijs wit (RAL9002)
Offset	32 mm
Zwenk radius	90 mm
Draaicirkel	180 mm
Diameter koepel	52 mm

FITTING

Type bevestiging	Rechthoekige plaat
Lengte plaat	95 mm
Breedte plaat	70 mm
Lengte plaatgat (maximaal)	75 mm
Breedte plaatgat (maximaal)	50 mm
Diameter plaatgat	11 mm



Deutscher
Ontwerper
Club



Interzum
Award



IF
Design
Award

LINEA

5940UAC100P51 RAL9002

EAN 4031582352924



BETTER MOBILITY. BETTER LIFE.

TECHNISCHE TEKENINGEN

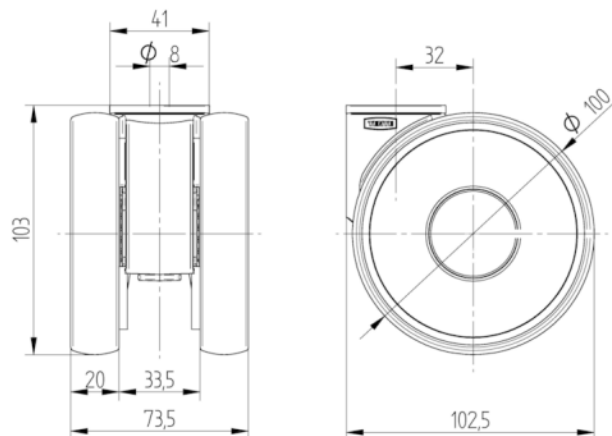

Deutscher
Ontwerper
Club



Interzum
Award



IF
Design
Award