

DURATECH

MOP 200x80-Ø40 HL90

EAN 4031582320060



BETTER MOBILITY. BETTER LIFE.



Image may differ from the original product

WHEEL

Body material	Polyamide, super heavy
Tread Material Mix	Identical with wheel body
Bearing	Precision ball bearing
Wheel Color	Natural white
Threadguards	Without threadguard
Diameter	200 mm
Tread width	80 mm
Axle Hole Diameter	40 mm
Hub Length	90 mm
Body width	80 mm
Hardness of tread (D)	75 Shore D
Bearing type	6308

PERFORMANCE

Roll Performance	● ● ● ● ●
Movement Noise	● ● ○ ○ ○
Attrition	● ● ● ● ●
Corrosion Resistance	● ● ● ○ ○

CORE ATTRIBUTES

Product Name	Duratech
Type	Wheel
Standard	EN12533 - Heavy Duty Castors
Load capacity at 4 km/h	5400 kg
Load capacity at 6 km/h	4500 kg
Electric Conductive	No
Stainless	No
Load capacity Static	9000 kg
Temperature range (Minimum)	-40 °C
Temperature range (Maximum)	80 °C
Overall weight	3.86 kg

DURATECH

MOP 200x80-Ø40 HL90

EAN 4031582320060

Order number 00830849
Product Drawings



BETTER MOBILITY. BETTER LIFE.

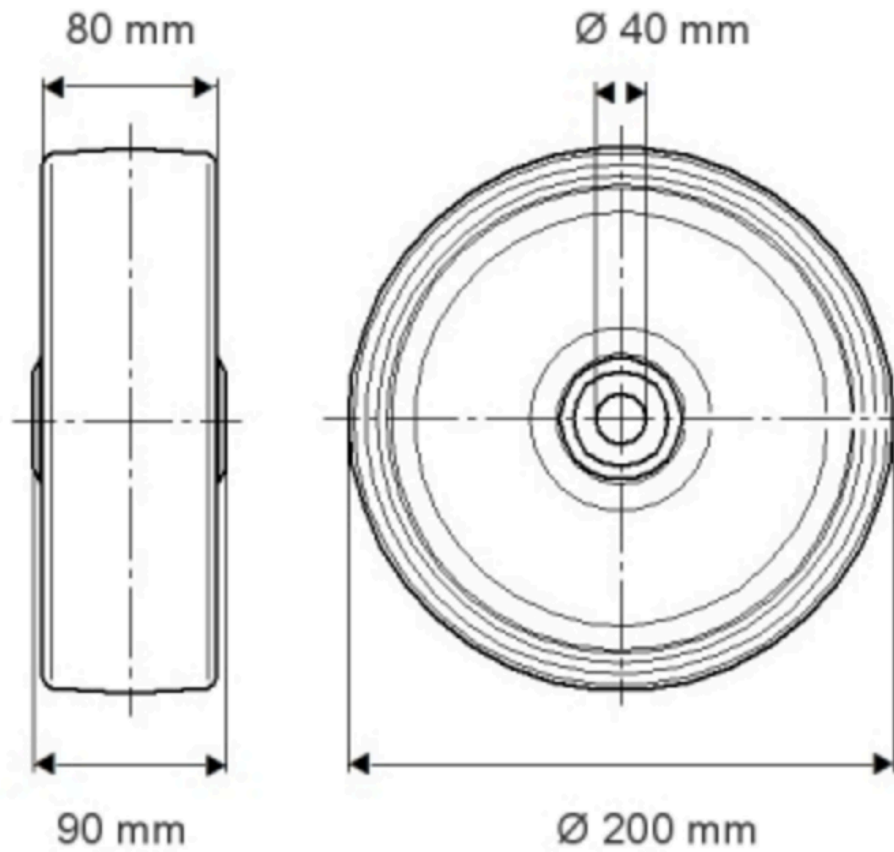

PRODUCT INFORMATION

DURATECH

MOP 200x80-Ø40 HL90

EAN 4031582320060

Order number 00830549

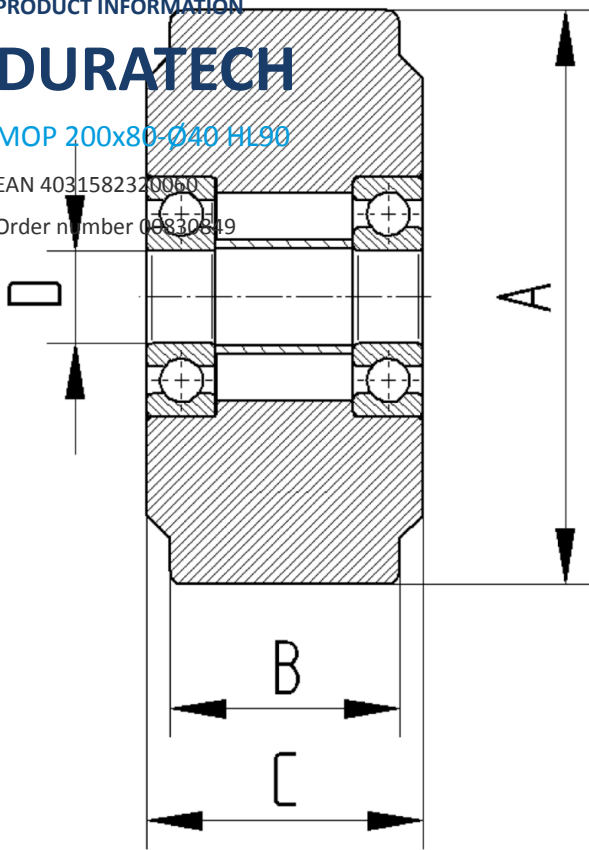

BETTER MOBILITY. BETTER LIFE.