

LINEA

5941UAP100R05-28 RAL9002

EAN 4031582368741



BETTER MOBILITY. BETTER LIFE.



Image may differ from the original product

PERFORMANCE

Roll performance	● ● ● ● ●
Movement noise	● ● ● ○ ○
Attrition	● ● ● ● ○
Corrosion resistance	● ● ● ● ○

CORE ATTRIBUTES

Product name	Linea
Type	Swivel castor with directional lock
Standard	EN12530 - Devices Castors
Load capacity at 1.8 mph	264.55 lb
Load capacity Static	529.11 lb
Temperature range (Minimum)	14 °F
Temperature range (Maximum)	104 °F
Overall height	4.72 in
Overall width	3.23 in
Overall weight	2.05 lb

WHEEL

Body material	Polyamide
Tread material	Polyurethane, injected
Bearing	Precision ball bearing
Threadguards	With threadguard
Diameter	3.94 in
Tread width	0.79 in
Hardness of tread (A)	92 Shore A

HOUSING

Material	Polyamide
Fork shape	Twin wheel housing
Swivel bearing	Precision ball bearing
Color	Gray white (RAL9002)
Offset	1.26 in
Swivel radius	4.25 in
Swivel interference	8.5 in
Dome diameter	2.05 in

FITTING

Fitting type	Solid stem, round
Bolt diameter	1.1 in
Bolt length	1.57 in



LINEA

5941UAP100R05-28 RAL9002

EAN 4031582368741



BETTER MOBILITY. BETTER LIFE.

TECHNICAL DRAWINGS

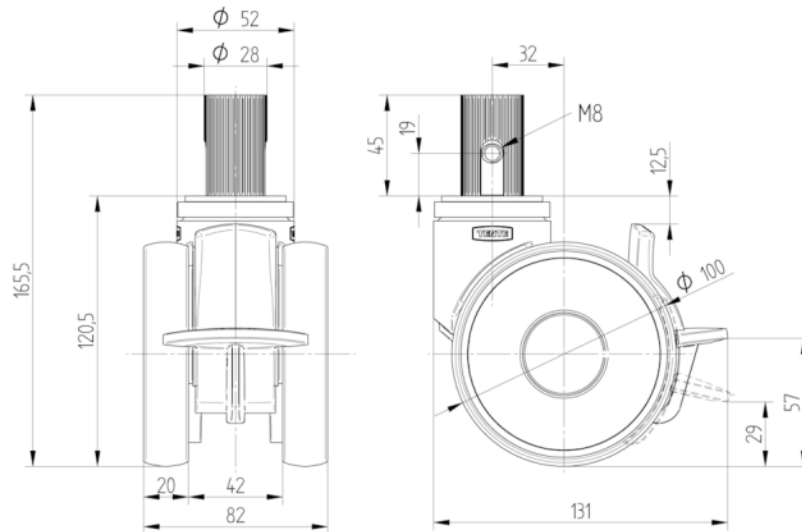

Deutscher
Designer
Club



Interzum
Award



IF
Design
Award