

NOVATECH

FTP 250x60-Ø30 HL60

EAN 4031582319408



BETTER MOBILITY. BETTER LIFE.



Image may differ from the original product

WHEEL

Body material	Cast iron
Tread Material Mix	Polyurethane, casted
Bearing	Precision ball bearing
Wheel Color	Honey yellow (RAL1005)
Threadguards	With threadguard
Diameter	250 mm
Tread width	60 mm
Axle Hole Diameter	30 mm
Hub Length	60 mm
Body width	60 mm
Hardness of tread (A)	92 Shore A
Hardness of tread (D)	42 Shore D

PERFORMANCE

Roll Performance	●●●●○
Movement Noise	●●●○○
Attrition	●●●●○
Corrosion Resistance	●●●○○

CORE ATTRIBUTES

Product Name	Novatech
Type	Wheel
Standard	EN12533 - Heavy Duty Castors
Load capacity at 4 km/h	1680 kg
Load capacity at 6 km/h	1400 kg
Electric Conductive	No
Stainless	No
Load capacity Static	2800 kg
Temperature range (Minimum)	-10 °C
Temperature range (Maximum)	60 °C
Overall weight	7.06 kg

NOVATECH

FTP 250x60-Ø30 HL60

EAN 4031582319408

Order number 00801341
Product Drawings



BETTER MOBILITY. BETTER LIFE.

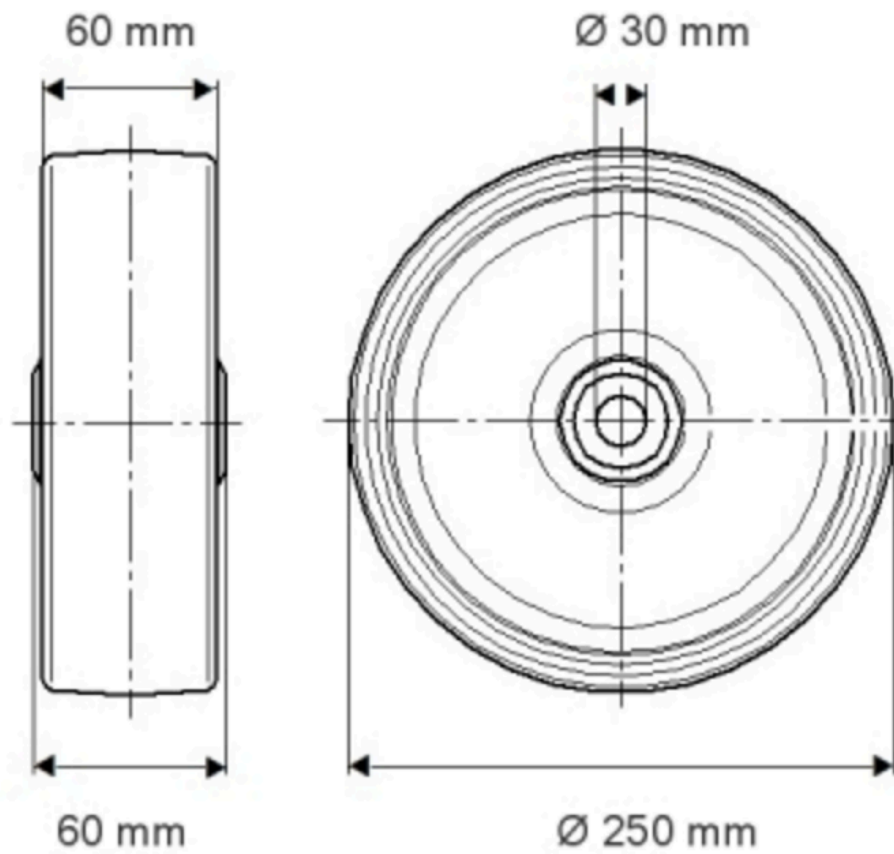

PRODUCT INFORMATION

NOVATECH

FTP 250x60-030 H160

EAN 4031582319408

Order number 00801341

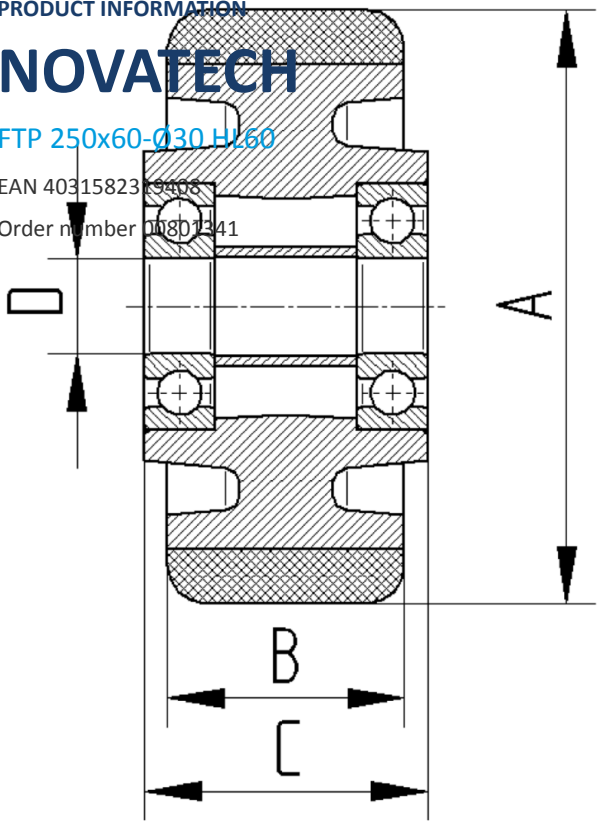

BETTER MOBILITY. BETTER LIFE.