

PRODUCT INFORMATION

DURATECH

TOP 160x50-Ø20 HL60

EAN 4031582322705



BETTER MOBILITY. BETTER LIFE.



Image may differ from the original product

WHEEL

Body material	Polyamide, heavy
Tread Material Mix	Identical with wheel body
Bearing	Precision ball bearing
Wheel Color	Natural white
Threadguards	Without threadguard
Diameter	160 mm
Tread width	50 mm
Axle Hole Diameter	20 mm
Hub Length	60 mm
Body width	50 mm
Hardness of tread (D)	75 Shore D
Bearing type	6204

PERFORMANCE

Roll Performance	●●●●●
Movement Noise	●●○○○
Attrition	●●●●●
Corrosion Resistance	●●●○○

CORE ATTRIBUTES

Product Name	Duratech
Type	Wheel
Standard	EN12533 - Heavy Duty Castors
Load capacity at 4 km/h	1020 kg
Load capacity at 6 km/h	850 kg
Electric Conductive	No
Stainless	No
Load capacity Static	1700 kg
Temperature range (Minimum)	-40 °C
Temperature range (Maximum)	80 °C
Overall weight	1.07 kg

DURATECH

TOP 160x50-Ø20 HL60

EAN 4031582322705

Order number 00801134
Product Drawings



BETTER MOBILITY. BETTER LIFE.

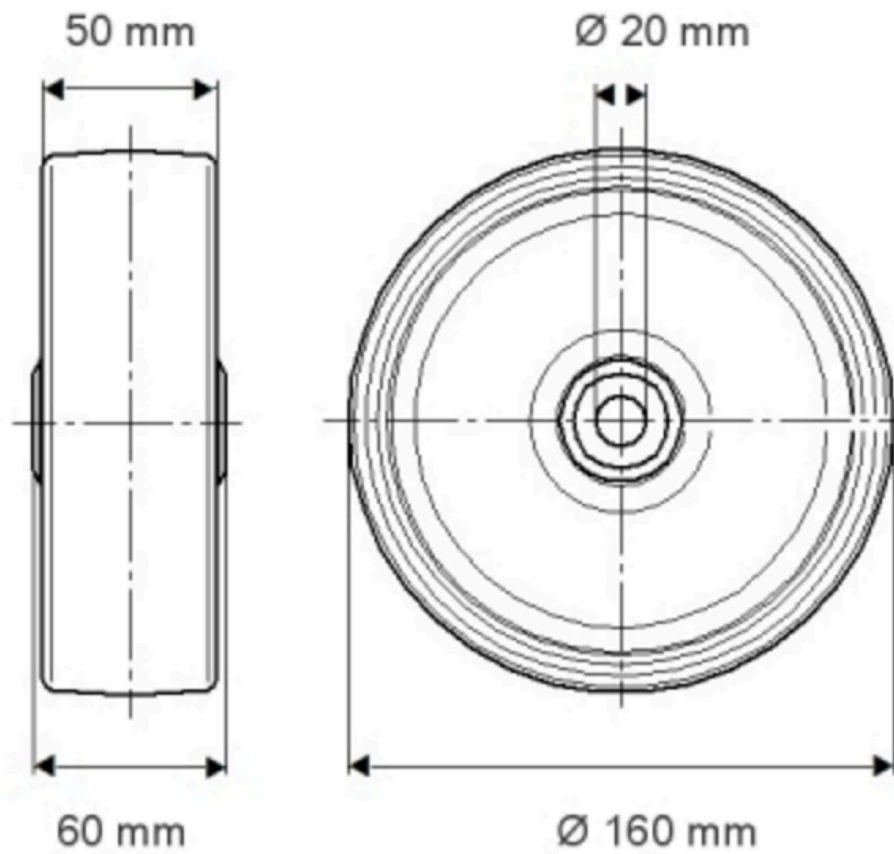

PRODUCT INFORMATION

DURATECH

TOP 160x50-Ø20 HL60

EAN 4031582322705

Order number 007801134



BETTER MOBILITY. BETTER LIFE.

