

LEVINA

5371PIO125P30-13 XL

EAN 4031582382150



BETTER MOBILITY. BETTER LIFE.



Image may differ from the original product

PERFORMANCE

Roll performance	● ● ● ○ ○
Movement noise	● ● ● ○ ○
Attrition	● ● ● ○ ○
Corrosion resistance	● ● ● ○ ○

CORE ATTRIBUTES

Product name	Levina
Type	Swivel castor with directional lock
Standard	EN12530 - Devices Castors
Load capacity at 3 km/h	80 kg
Load capacity Static	160 kg
Temperature range (Minimum)	-10 °C
Temperature range (Maximum)	40 °C
Overall height	161 mm
Overall weight	0.59 kg

WHEEL

Body material	Polypropylene
Tread material	Solid rubber, non-marking
Bearing	Plain bearing
Threadguards	Without threadguard
Diameter	125 mm
Tread width	32 mm
Hardness of tread (A)	80 Shore A

HOUSING

Material fork	Polyamide
Fork shape	Slim
Swivel bearing	Two ball races
Offset	38.5 mm
Swivel radius	130 mm
Swivel interference	260 mm

FITTING

Fitting type	Bolt hole
Bolt hole diameter	13 mm



Universal Design Award



Deutscher Designer Club

LEVINA

5371PIO125P30-13 XL

EAN 4031582382150



BETTER MOBILITY. BETTER LIFE.

TECHNICAL DRAWINGS

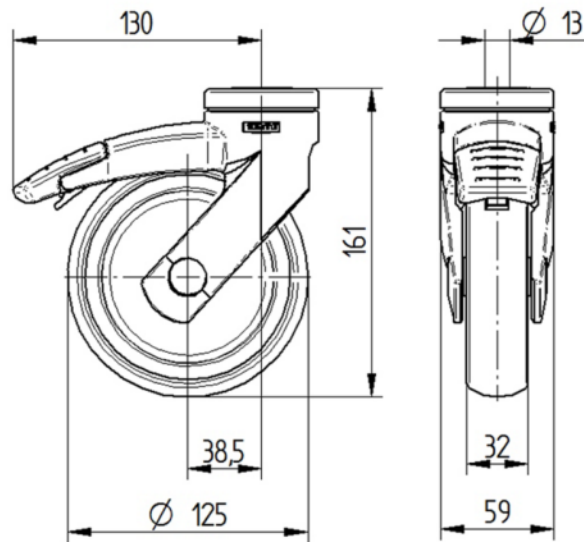

Universal
Design
Award



Deutscher
Designer
Club