

ULTRATECH

ICP200x50-Ø20 soft

EAN 4031582445114



BETTER MOBILITY. BETTER LIFE.



Afbeelding kan afwijken van het oorspronkelijke product

WIEL

Tread hardness	zacht
Materiaal wielkern	Aluminium
Materiaal loopvlak	Ultratech polyurethaan, Gegoten
Lagering	Precisie kogellagers
Afdekkapjes	Zonder schroefdraadbeschermer
Diameter	200 mm
Breedte Loopvlak	50 mm
Diameter Asgat	20 mm
Naaflengte	60 mm
Hardheid van het Loopvlak (A)	75 Shore A

PRESTATIES

Rolprestaties	● ● ● ● ○
Bewegingsgeluid	● ● ● ● ○
Slijtage	● ● ● ● ● ○
Corrosiebestendigheid	● ● ● ● ○

KERNKENMERKEN

Productnaam	Ultratech
Type	Wiel
Standaard	EN12532 - Transportuitrusting
Draagvermogen bij 4 km/h	800 kg
Draagvermogen bij 6 km/h	640 kg
Elektrisch geleidend	Nee
Roestvrij	Nee
Statisch draagvermogen	1600 kg
Temperatuurbereik (minimaal)	-20 °C
Temperatuurbereik (maximaal)	60 °C
Totaal gewicht	1,3 kg

ULTRATECH

ICP200x50-Ø20 soft

EAN 4031582445114



BETTER MOBILITY. BETTER LIFE.

Product Drawings



PRODUCTINFORMATIE

ULTRATECH

ICP200x50-Ø20 soft

EAN 4031582445174

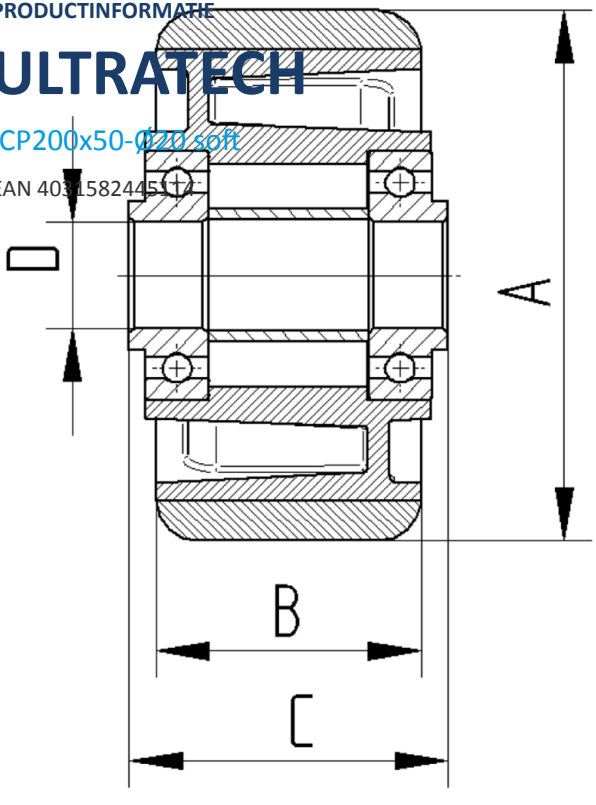

BETTER MOBILITY. BETTER LIFE.