

LEVINA

5377PIP100R05-28X45

EAN 4031582363029



BETTER MOBILITY. BETTER LIFE.



Afbeelding kan verschillen van het oorspronkelijke product

PRESTATIES

Rolprestaties	● ● ● ○ ○
Bewegingsgeluid	● ● ● ● ●
Verloop	● ● ● ○ ○
Corrosieweerstand	● ● ● ● ●

KERNKENMERKEN

Productnaam	Levina
Type	Zwenkwiel met dubbele rem
Standaard	EN12530 - Apparaten zwenkwielen
Draagvermogen bij 3 km/u	80 kg
Statisch Draagvermogen	160 kg
Temperatuurbereik (minimaal)	-10 °C
Temperatuurbereik (maximaal)	40 °C
Totale hoogte	137 mm

WIEL

Wielkern materiaal	Polypropyleen
	zacht
Materiaal loopvlak	Massief rubber, niet-markerend
Lager	Precisiekogellagers
Afdekkapjes	Met afdekkapjes
Diameter	100 mm
Breedte Loopvlak	32 mm
Hardheid van het loopvlak (A)	75 Shore A

VORK

Materiaal	Polyamide
Vork Vorm	Slank
Zwenklager	Dubbele kogeldraaikrans
Offset	36 mm
Zwenk radius	98 mm
Uitzwenking	196 mm

BEVESTIGING

Type bevestiging	Vaste Stift, rond
Diameter Bout	28 mm
Lengte Bout	45 mm

Universele
Design
AwardDuitse
OntwerpersClub

LEVINA

5377PIP100R05-28X45

EAN 4031582363029



BETTER MOBILITY. BETTER LIFE.

TECHNISCHE TEKENINGEN

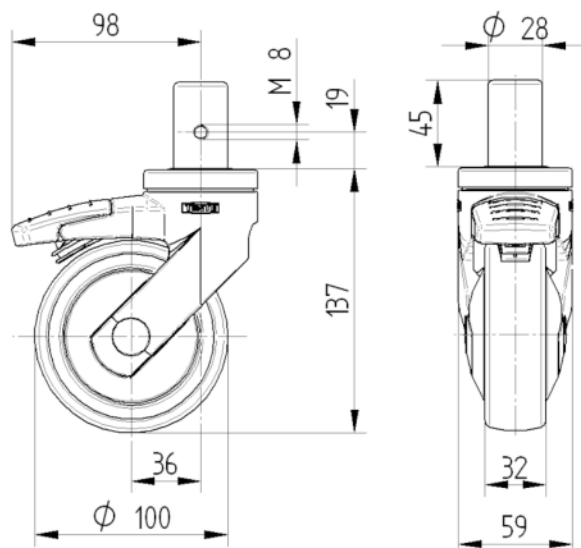

Universele
Design
Award



Duitse
OntwerpersClub