

LEVINA

5377PJO125P30-11 XL

EAN 4031582382259



BETTER MOBILITY. BETTER LIFE.



Slika se može razlikovati od originalnog proizvoda

PERFORMANSE

Performanse kotrljanja ●●●○○

Buka u pokretu ●●●●○

Ishrana ●●●●○

otpornost na rdju ●●●●○

OSNOVNI ATRIBUTI

Naziv proizvoda	Levina
Tip	Okreni Tocak sa potpuna kocnica
Standard	EN12530 - Kastori uređaja
Nosivost na 3 km/h	100 kg
Statički Nosivost	200 kg
Temperaturni opseg (Minimalno)	-10 °C
Opseg temperature (maksimalni)	40 °C
Sveukupna visina	161 mm
Ukupna težina	0,53 kg

TOCAK

Materijal za telo	polipropilen
materijal omotaca	Termoplastična guma
Nošenje	klizni lezaj
stitnici omotaca	Bez stražara
Prečnik	125 mm
Širina omotac	32 mm
Teškoća gazećeg omotac (A)	85 Šora A

KUCISTE

Materijal	poliamid
oblik viljuska	Slim
okretni lezaj	Dve lopte
ofset	38,5 mm
okretni radijus	130 mm
Otpor okretanju	260 mm

PRILAGOĐAVANJE

Tip uklapanja	otvor za vijak
dimenzija rupa sraf	11 mm

Univerzalna
nagrada DizajnDeutscher
dizajner
Club

LEVINA

5377PJO125P30-11 XL

EAN 4031582382259



BETTER MOBILITY. BETTER LIFE.

TEHNIČKI CRTEŽI

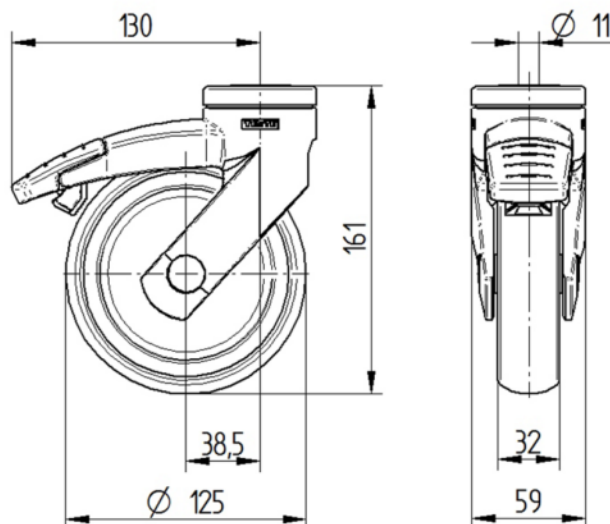

Univerzalna
nagrada Dizajn



Deutscher
dizajner
Club