

# NOVATECH

FTP 150x50-Ø25 HL60

EAN 4031582329476



BETTER MOBILITY. BETTER LIFE.



Image may differ from the original product

## WHEEL

Body material	Cast iron
Tread Material Mix	Polyurethane, casted
Bearing	Precision ball bearing
Wheel Color	Honey yellow (RAL1005)
Threadguards	With threadguard
Diameter	150 mm
Tread width	50 mm
Axle Hole Diameter	25 mm
Hub Length	60 mm
Body width	50 mm
Hardness of tread (A)	92 Shore A
Hardness of tread (D)	42 Shore D

## PERFORMANCE

Roll Performance	●●●●○
Movement Noise	●●●○○
Attrition	●●●●○
Corrosion Resistance	●●●○○

## CORE ATTRIBUTES

Product Name	Novatech
Type	Wheel
Standard	EN12533 - Heavy Duty Castors
Load capacity at 4 km/h	840 kg
Load capacity at 6 km/h	700 kg
Electric Conductive	No
Stainless	No
Load capacity Static	1400 kg
Temperature range (Minimum)	-10 °C
Temperature range (Maximum)	60 °C
Overall weight	3.56 kg

# NOVATECH

FTP 150x50-Ø25 HL60

EAN 4031582329476

Order number 00802328  
Product Drawings



BETTER MOBILITY. BETTER LIFE.

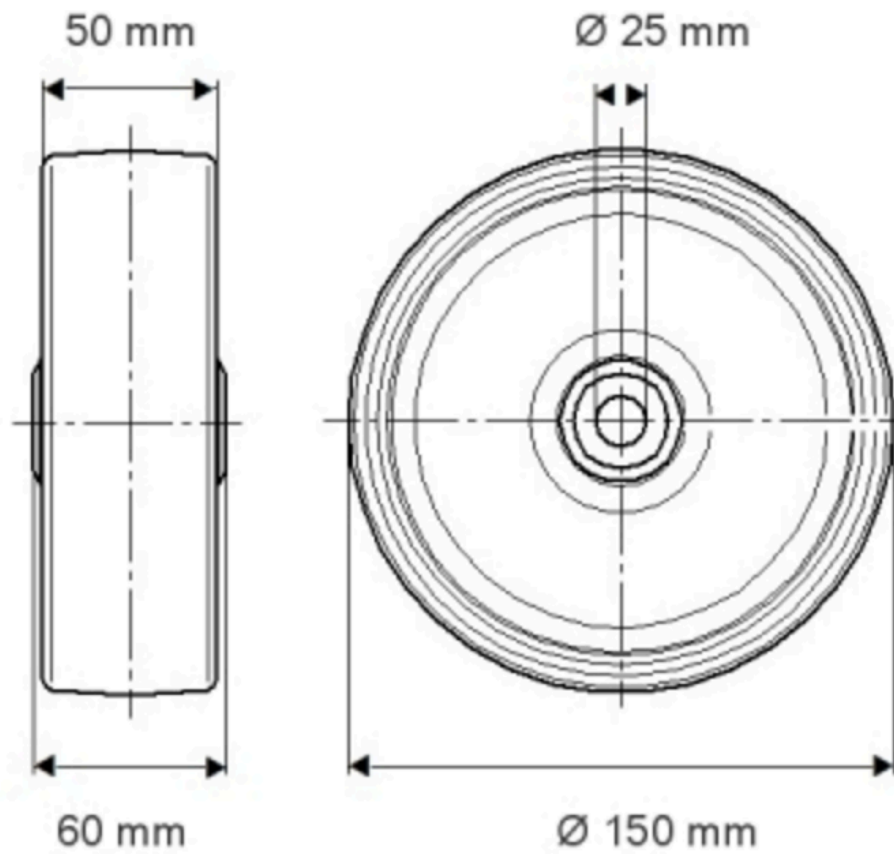

PRODUCT INFORMATION

# NOVATECH

FTP 150x50-025 H160

EAN 4031582329476

Order number 00802328

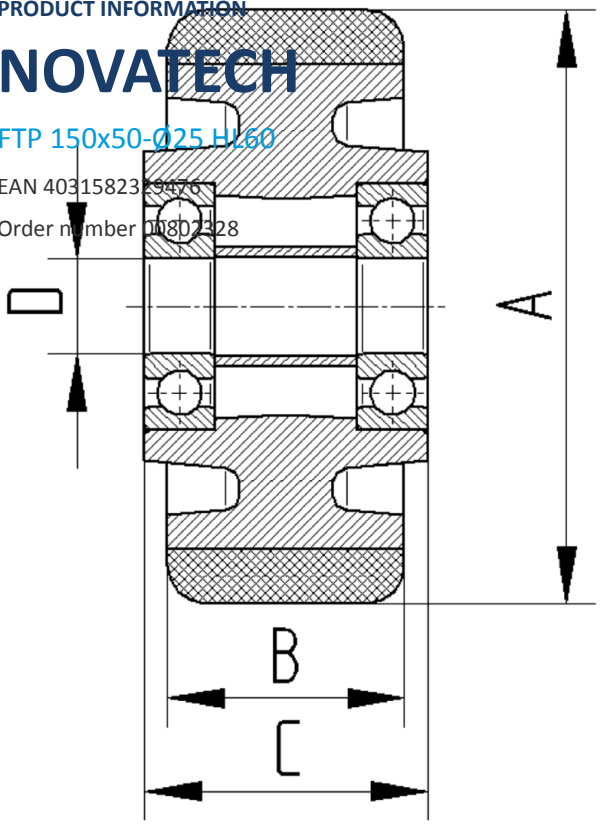

BETTER MOBILITY. BETTER LIFE.