

DURATECH

MOP 250x50-Ø40 HL60

EAN 4031582320077



BETTER MOBILITY. BETTER LIFE.



Image may differ from the original product

WHEEL

Body material	Polyamide, super heavy
Tread Material Mix	Identical with wheel body
Bearing	Precision ball bearing
Wheel Color	Natural white
Threadguards	Without threadguard
Diameter	250 mm
Tread width	50 mm
Axle Hole Diameter	40 mm
Hub Length	60 mm
Body width	50 mm
Hardness of tread (D)	75 Shore D
Bearing type	6308

PERFORMANCE

Roll Performance	● ● ● ● ●
Movement Noise	● ● ○ ○ ○
Attrition	● ● ● ● ●
Corrosion Resistance	● ● ● ○ ○

CORE ATTRIBUTES

Product Name	Duratech
Type	Wheel
Standard	EN12533 - Heavy Duty Castors
Load capacity at 4 km/h	4200 kg
Load capacity at 6 km/h	3500 kg
Electric Conductive	No
Stainless	No
Load capacity Static	8400 kg
Temperature range (Minimum)	-40 °C
Temperature range (Maximum)	80 °C
Overall weight	3.89 kg

DURATECH

MOP 250x50-Ø40 HL60

EAN 4031582320077

Order number 00801034
Product Drawings



BETTER MOBILITY. BETTER LIFE.

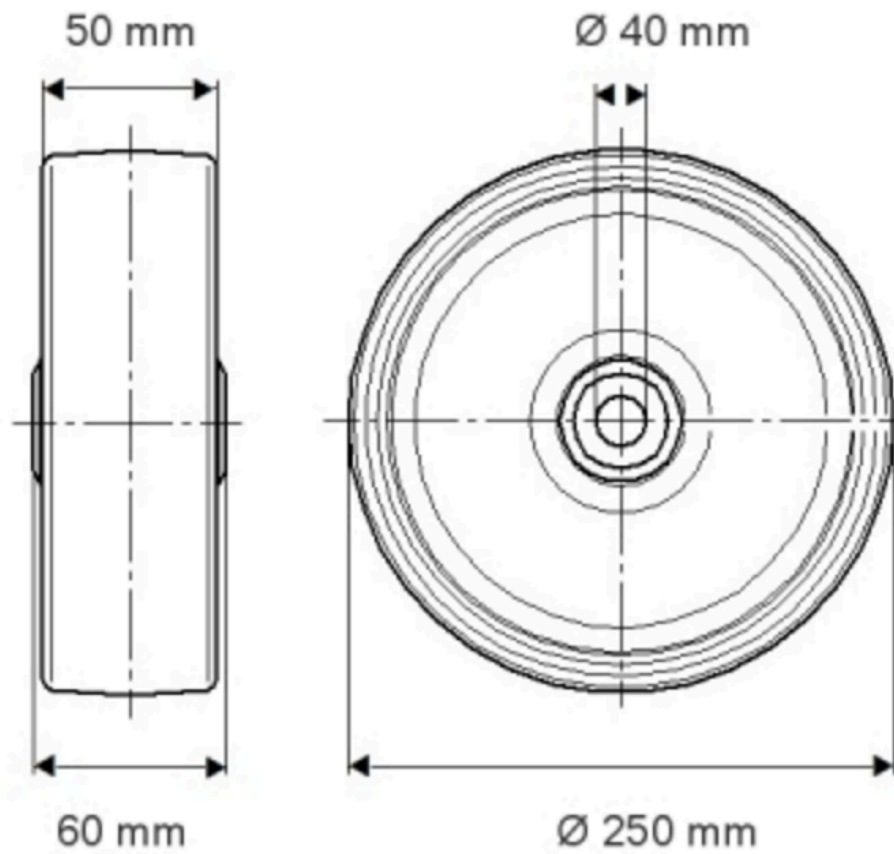

PRODUCT INFORMATION

DURATECH

MOP 250x50-Ø40 HL60

EAN 4031582320077

Order number 00801684

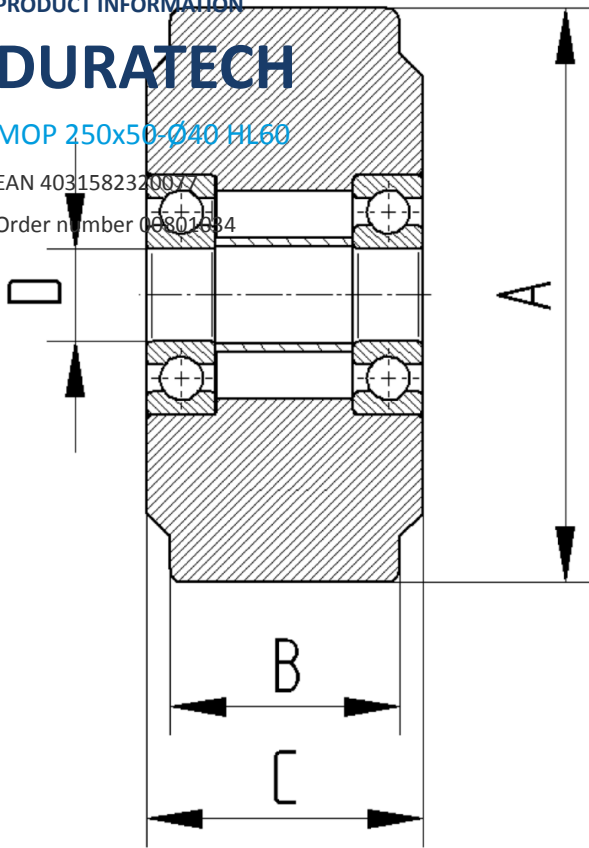

BETTER MOBILITY. BETTER LIFE.